

VERLIS®

User Manual



EAZ0061B40D Rev. A

Legal Information

Trademarks

Snap-on, ShopStream Connect, ShopKey, ShopKey Pro and VERUS are trademarks registered in the United States and other countries of Snap-on Incorporated. All other marks are trademarks or registered trademarks of their respective holders.

Copyright Information

© 2014 Snap-on Incorporated. All rights reserved.

Disclaimer of Warranties and Limitation of Liabilities

The information, specifications and illustrations in this manual are based on the latest information available at the time of printing. While the authors have taken due care in the preparation of this manual, nothing contained herein:

- Modifies or alters in any way the standard terms and conditions of the purchase, lease, or rental agreement under the terms of which the equipment to which this manual relates was acquired.
- Increases in any way the liability to the customer or to third parties.

Snap-on reserves the right to make changes at any time without notice.

IMPORTANT:

Before operating or maintaining this unit, please read this manual carefully paying extra attention to the safety warnings and precautions.

Regulatory Information



This product has been tested to the requirements of CAN/CSA-C22-2 No. 61010-1, second edition, including Amendment 1, or a later version of the same standard incorporating the same level of testing requirements.

Contact Information

Visit our websites at:

(United Kingdom) <http://diagnostics.snapon.co.uk>

(Australia and New Zealand) snapontools.com.au

ShopStream Connect

(United Kingdom) <http://www1.snapon.com/diagnostics/UK/Diagnostics/ShopStreamConnect.htm>

(Australia and New Zealand) http://snapontools.com.au/diagnostics/downloads/shopstream_connect_software

For Technical Assistance

Phone / E-mail:

(United Kingdom) +44 (0) 845 601 4736 / diagnosticsUKproductsupport@snapon.com

(Australia) 1-800-810-581 / sota.diagnostics@snapon.com

(New Zealand) 1-800-441-762 / sota.diagnostics@snapon.com

For technical assistance in all other markets, contact your selling agent.

EAZ0061B40D Rev. A 7-G-14 GB/AU

EC-DECLARATION OF CONFORMITY

We,

Snap-on Diagnostics
a division of Snap-on UK Holdings Ltd.
Denney Road, King's Lynn
Norfolk, PE30 4HG
England

declare under our sole responsibility for design and manufacture that the following product, to which this declaration relates, is in conformity with the following European Directives:

EMC Directive: EN61326-1 (2006)4, EN61000-3-2 (2006), EN61000-3-3 (1995)
89/336/EEC, 2004/108/EC

Product: VERUS

Model: EEMS323 Diagnostic Platform
EAK0294B02A Cradle Charger Kit

Applied Safety standard: 61010-1, 61010-2-031

King's Lynn, 9-03-2009

Name : A. Barker

Position : Director European Supply Chain

Signature



Safety Information

For your own safety and the safety of others, and to prevent damage to the equipment and vehicles upon which it is used, it is important that the accompanying *Important Safety Instructions* be read and understood by all persons operating, or coming into contact with, the equipment. We suggest you store a copy near the unit in sight of the operator.

This product is intended for use by properly trained and skilled professional automotive technicians. The safety messages presented throughout this manual are reminders to the operator to exercise extreme care when using this test instrument.

There are many variations in procedures, techniques, tools, and parts for servicing vehicles, as well as in the skill of the individual doing the work. Because of the vast number of test applications and variations in the products that can be tested with this instrument, we cannot possibly anticipate or provide advice or safety messages to cover every situation. It is the automotive technician's responsibility to be knowledgeable of the system being tested. It is essential to use proper service methods and test procedures. It is important to perform tests in an appropriate and acceptable manner that does not endanger your safety, the safety of others in the work area, the equipment being used, or the vehicle being tested.

It is assumed that the operator has a thorough understanding of vehicle systems before using this product. Understanding of these system principles and operating theories is necessary for competent, safe and accurate use of this instrument.

Before using the equipment, always refer to and follow the safety messages and applicable test procedures provided by the manufacturer of the vehicle or equipment being tested. Use the equipment only as described in this manual.

Read, understand and follow all safety messages and instructions in this manual, the accompanying safety manual, and on the test equipment.

Safety Signal Words

Safety messages are provided to help prevent personal injury and equipment damage. All safety messages are introduced by a signal word indicating the hazard level.

DANGER

Indicates an imminently hazardous situation which, if not avoided, will result in death or serious injury to the operator or to bystanders.

WARNING

Indicates a potentially hazardous situation which, if not avoided, could result in death or serious injury to the operator or to bystanders.

CAUTION

Indicates a potentially hazardous situation which, if not avoided, may result in moderate or minor injury to the operator or to bystanders.

Safety Message Conventions

Safety messages are provided to help prevent personal injury and equipment damage. All safety messages are introduced by a signal word indicating the hazard level.

Safety messages communicate the hazard, hazard avoidance and possible consequences using three different type styles:

- Normal type states the hazard.
- Bold type states how to avoid the hazard.
- Italic type states the possible consequences of not avoiding the hazard.

An icon, when present, gives a graphical description of the potential hazard.

Example:

WARNING



Risk of unexpected vehicle movement.

- **Block drive wheels before performing a test with the engine running.**
A moving vehicle can cause injury.

Important Safety Instructions

For a complete list of safety messages, refer to the accompanying safety information.

SAVE THESE INSTRUCTIONS

Contents

Safety Information	iv
Contents	vi
Chapter 1: Using This Manual	1
Conventions	1
Bold Text	1
Symbols	1
Terminology	1
Notes and Important Messages	2
Procedures	2
Hyperlinks	2
Tool Help	2
Chapter 2: Introduction	3
Features and Specifications	4
Features	4
Technical Specifications	7
The Stand	8
Wrist Strap (Optional)	8
Control Buttons	9
LEDs	9
Power Conservation	9
Power Sources	10
Scan Module (United Kingdom Only)	11
Functional Description	11
Technical Specifications	12
Power Sources	12
Chapter 3: Getting Started	13
Turning On	13
Function Icons	14
VERUS Toolbar	15
Windows Toolbar	18
Turning Off	18
Emergency Shutdown	18
Chapter 4: Scanner Operations	19
Getting Started	19
The Demonstration Program	20
Disconnecting the VERUS Diagnostic Tool From a Vehicle	21
Vehicle Identification	22
Alternative Vehicle Identification	23
Menu Options, Scanner	24
Connecting to a Vehicle	27
Data Cable Connection	27
No Communication Message	28
Navigation	29

Scan Module Screen Layout.....	29
Screen Messages	32
Making Selections.....	32
Operations	33
Data Display.....	34
Codes Menu.....	41
Functional Tests.....	44
Generic Functions.....	46
Scanner Toolbar Operations.....	46
Exiting the Scanner	54
Downloading Firmware.....	55
Chapter 5: OBD Direct.....	58
OBD Health Check	59
Global OBD II Code Check	59
Global OBD II Clear Codes.....	60
Readiness Monitors	60
MIL Status.....	61
OBD Diagnose.....	61
Start Communication	61
Connector Information	64
Manual Protocol Selection	65
Chapter 6: Guided Component Test.....	66
Vehicle Identification.....	66
Menu Options, Guided Component Test.....	67
Identifying a Test Vehicle.....	68
Operations	70
Component Information	70
Tests	71
VERUS Toolbar Menu Options	74
Chapter 7: Scope Multimeter.....	76
Getting Started	76
Capabilities	76
Leads, Probes and Adapters	78
Menu Options, Scope Multimeter.....	81
Navigation.....	82
Screen Layout.....	82
Making Selections.....	87
Operations	88
Starting the Scope and Multimeter.....	88
Measurement Out of Range.....	90
Scope and Multimeter Setup.....	90
Chapter 8: Information.....	103
Vehicle Identification.....	104
Diagnostic Trouble Codes	105
Diagnostic Trouble Codes Screen	106
Printing Diagnostic Trouble Code Information	106
Engine Management Component Testing	107
Engine Management Component Testing Screen	108

Engine Management Pin Data.....	110
View Tabs	111
Information Tabs	111
Component Selection.....	111
Component Locations.....	111
Wiring Diagrams	113
Toolbar	114
Component Selection Menu.....	114
Full-width Window	114
Magnified Window.....	114
Chapter 9: Vehicle History Operations.....	115
Screen Layout	115
Vehicle History Main Body	116
Vehicle History Toolbar	116
Chapter 10: Data Manager	120
Screen Layout	120
My Data.....	121
Open	122
New.....	123
Delete.....	124
Rename	125
Properties.....	126
More	126
Saved File Structure	127
Chapter 11: Help Operations.....	128
Using the Help Toolbar.....	128
Chapter 12: System Settings Operations.....	130
Paired Devices	130
Pairing the Wireless Scan Module	131
Shop Information.....	133
Chapter 13: Maintenance	134
Cleaning the Touch Screen	134
Calibrating the Touch Screen	134
Cleaning and Inspecting the Diagnostic Tool	135
Fan Filter Service	135
Battery Pack Service	136
Battery Pack Safety Guidelines	136
Replacing the Battery Pack.....	137
Disposing of the Battery Pack.....	137
Battery Pack Calibration	138
VERUS System Restore.....	138
Wireless Scan Module.....	139
Replacing the Protective Handgrip.....	139
Appendix A: Troubleshooting Bluetooth Communication Issues.....	140
Index	144

This manual contains basic operating instructions and is structured in a manner to help you become familiar with your Diagnostic Tool features and perform basic operations.

The illustrations in this manual are intended as reference only and may not depict actual screen results, information, functions or standard equipment. Contact your sales representative for availability of other functions and optional equipment.

1.1 Conventions

1.1.1 Bold Text

Bold emphasis is used in procedures to highlight selectable items such as buttons and menu options.

Example:

- Select **Functions**.

1.1.2 Symbols

The “greater than” arrow (>) indicates an abbreviated set of selection instructions.

Example:

- Select **Utilities > Tool Setup > Date**.

The above statement abbreviates the following procedure:

1. Select the **Utilities** icon.
2. Select the **Tool Setup** submenu.
3. Highlight the **Date** option from the submenu.

1.1.3 Terminology

The term “select” describes tapping/touching an icon on the touch screen, or highlighting an icon or menu choice and then selecting the confirmation menu choice such as **Continue, Accept, OK, Yes**, or other similar choice.

Example:

- Select **Reset**.

The above statement abbreviates the following procedure:

1. Navigate to the **Reset** icon.
2. Select the **Reset** icon with your stylus.

1.1.4 Notes and Important Messages

The following messages are used.

Note

A note provides helpful information such as additional explanations, tips, and comments.

Example:

**NOTE:**

For additional information refer to...

Important

Important indicates a situation which, if not avoided, may result in damage to the test equipment or vehicle.

Example:

IMPORTANT:

Disconnecting the USB cable during vehicle communication can cause damage to the ECM.

1.1.5 Procedures

An arrow icon indicates a procedure.

Example:

**To change screen views:**

1. Select **View**.
The dropdown menu displays.
2. Select an option from the menu.
The screen layout changes to the format you selected.

1.1.6 Hyperlinks

Hyperlinks, or links, that take you to other related articles, procedures, and illustrations are available in electronic documents. Blue colored text indicates a selectable hyperlink.

Example:

IMPORTANT:

Read all applicable [Safety Information](#) before using this tool!

1.1.7 Tool Help

To display help topics for this tool, select a help option from the Help menu.

This manual is intended for multiple international markets and may include information and procedures that are not applicable to your Diagnostic Tool.

This manual contains Verus Wireless and Scan Module operation information that is applicable only in the United Kingdom.

The VERUS® Diagnostic Tool is a specialized personal computer (PC) that combines information with test instrumentation to help you diagnose symptoms, codes, and complaints quickly and efficiently, test vehicle systems and components, access service records and recorded data, and verify repairs. VERUS forms a complete automotive diagnostic solution. There are two main components to the VERUS Diagnostic Tool:

- [Features and Specifications](#)—the central processor and system monitor with integral scope.
- [Scan Module \(United Kingdom Only\)](#)—the device for accessing vehicle data.

Microsoft Windows Embedded is the operating system of the Diagnostic Tool, which allows VERUS to run most Windows compatible software programs. The standard Windows toolbar displays at the bottom of the screen. Unique Snap-on software that allows VERUS to function as a scan tool, graphing multimeter, lab scope, and a powerful diagnostic database opens on startup.

2.1 Features and Specifications

2.1.1 Features

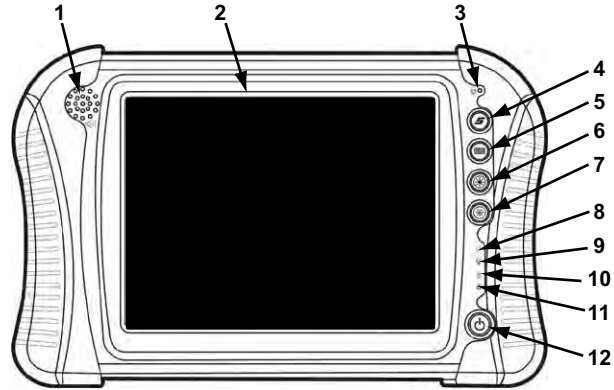

- 1— Audio Speaker
- 2— Touch Screen Display
- 3— Microphone
- 4— S (Shortcut) Button
- 5— Virtual Keyboard Button
- 6— Brightness Up Button
- 7— Brightness Down Button
- 8— Hard Drive Activity LED
- 9— Wireless LAN Activity LED
- 10— Battery Charging LED
- 11— Main Power LED
- 12— Power Button

Figure 2-1 Front view

IMPORTANT:

There are two versions of the VERUS Diagnostic Tool: the standard Diagnostic Tool with integral Scan Module that connects to the vehicle with a data cable, and the wireless unit that uses the stand-alone Scan Module and does not require a physical link to the test vehicle. The top view of the two models are distinctly different, as shown in the illustrations below. Earlier standard Diagnostic Tools can be converted to operate with the wireless Scan Module, contact your sales representative for details.

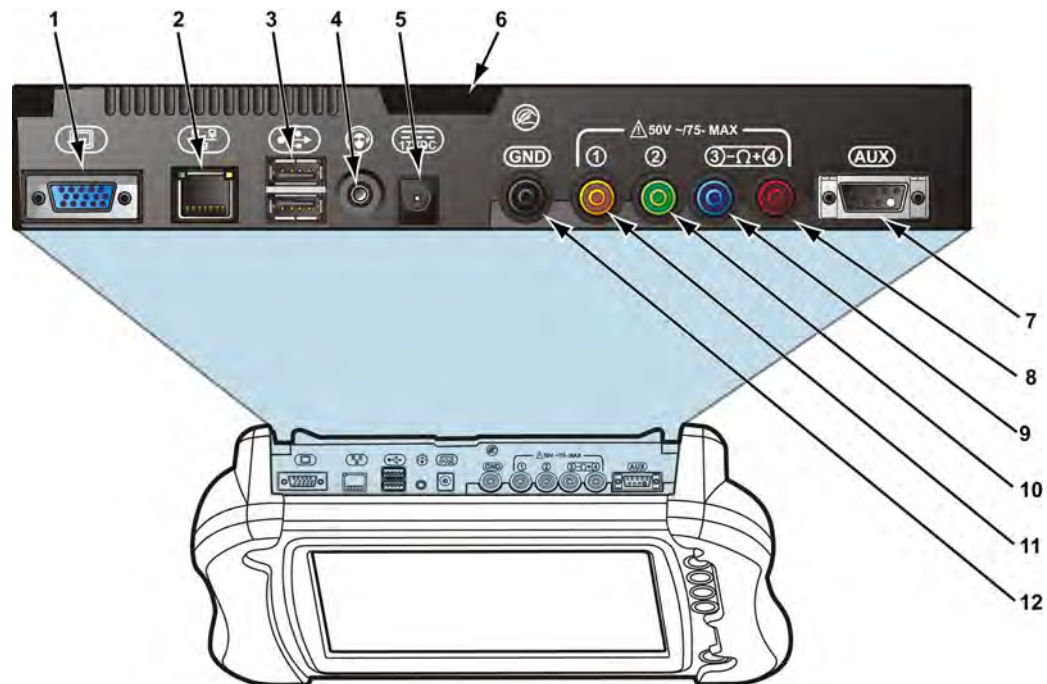

- 1— VGA (video graphics array) Connector
- 2— LAN (local area network) Jack
- 3— USB (universal serial bus) Jacks (2)
- 4— Audio (head phone) Jack
- 5— DC Power Supply Input Jack
- 6— Fan Filter
- 7— Scope Auxiliary Connector
- 8— Channel 4 Jack
- 9— Channel 3 Jack
- 10— Channel 2 Jack
- 11— Channel 1 Jack
- 12— Common Ground Jack

Figure 2-2 Top view, wireless model

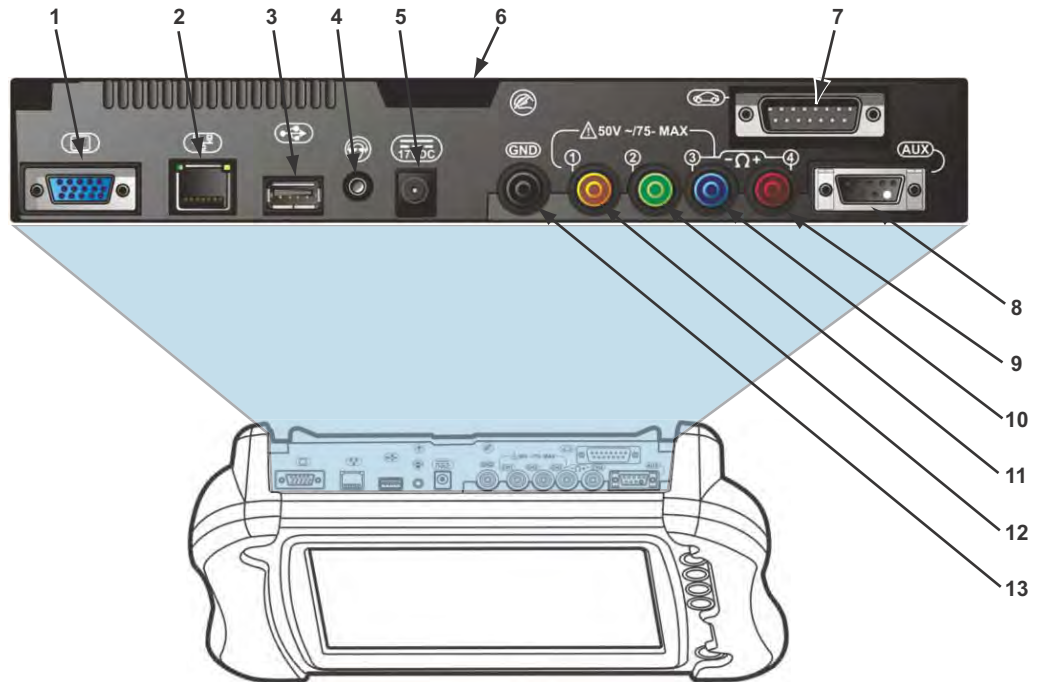

- 1— VGA (video graphics array) Connector
- 2— LAN (local area network) Jack
- 3— USB (universal serial bus) Jack
- 4— Audio (head phone) Jack
- 5— DC Power Supply Input Jack
- 6— Fan Filter
- 7— Data Cable Connector
- 8— Scope Auxiliary Connector
- 9— Channel 4 Jack
- 10—Channel 3 Jack
- 11—Channel 2 Jack
- 12—Channel 1 Jack
- 13—Common Ground Jack

Figure 2-3 Top view, standard model

2.1.2 Technical Specifications

Processor:

1.6GHz Intel Atom

Memory:

1GB RAM

Operating System

Microsoft Windows Embedded Standard (XPe SP3)

Touch Screen

5-wire Resistive Touch Panel

Display:

10.4 inch, outdoor enhanced, TFT LCD

1024 x 768 resolution

262,144 Colors

Battery:

Lithium Ion Smart Battery Pack

Approximately 4 hour run time

Approximately 4 hour charge time, VERUS not operating

Approximately 8 hour charge time, VERUS operating

Communications:

10/100 Ethernet Jack

802.11 b/g Wireless LAN

Bluetooth 2.0 Class 1

Dimensions:

Width:

14.9 inches

358 mm

Height:

9.17 inches

233 mm

Depth:

3.07 inches

78 mm

Weight (including battery):

7.5 lbs.

3402 g

Operating Temperature Range (ambient):

At 0 to 90% relative humidity (non-condensing)

32 to 113°F

0 to 45°C

Storage Temperature (ambient):

At 0 to 70% relative humidity (non-condensing)

–4 to 131°F

–20 to 55°C

Environmental Conditions:

This product is intended for indoor use only.

This product is rated for Pollution Degree 2 (normal conditions).

Power Supply:

Supply Rating; 12–17 VDC. 3.53A

Output; 17VDC 60W, LPS (limited power source)

2.1.3 The Stand





The VERUS Diagnostic Tool has a built-in, metal stand attached to the back. When the stand is not in use, it is secured to the back of the Diagnostic Tool by an integrated casing hook. When extended, the stand allows the Diagnostic Tool to rest at a 45° angle for hands-free viewing.

2.1.4 Wrist Strap (Optional)

An adjustable wrist strap that attaches to the back of the Diagnostic Tool to secure and stabilize the VERUS while you work is available as an option. Using the wrist strap allows the VERUS to comfortably rest on your forearm and leaves a hand free for connecting test leads and operating the touch screen. The strap also eliminates the possibility of the VERUS falling off a vehicle due to vibrations or other movement, and also prevents you from accidentally dropping the tool.

2.1.5 Control Buttons

There are five control buttons located on the right side of the Diagnostic Tool near the handgrip:

Name	Button	Description
S (Shortcut) Button		A function button that provides a shortcut for performing routine tasks.
Keyboard		Opens, and closes, a virtual keyboard on the touch screen.
Brightness Up		Incrementally increases the screen backlighting.
Brightness Down		Incrementally decreases the screen backlighting.
Power		Turns the Diagnostic Tool on and off. Also, press and hold for 5 seconds for emergency shutdown.

All other tool operations are controlled through the touch screen.

S (Shortcut) Button

Use the S Button to quickly capture an image of the current screen with a single button press. This screen capture function is available at all times, even when operating outside of the VERUS Diagnostic Tool software.

2.1.6 LEDs

The four light-emitting diodes indicate certain system conditions:

- Hard Drive Activity LED—illuminates when the central processing unit (CPU) is reading or writing to the hard disk drive (HDD).
- Wireless LAN Activity LED—illuminates when a wireless local area network (LAN) is enabled, flashes when data is being sent or received.
- Battery Charging LED—illuminates when the internal battery pack is charging.
- Main Power LED—illuminates when the Diagnostic Tool is powered on or in Standby mode.

2.1.7 Power Conservation

To conserve power, the VERUS Diagnostic Tool uses a power saving strategy when left idle. Standby mode engages following a period of inactivity. During standby, the random access memory (RAM) remains powered, but all other functions are turned off. The screen shuts off and the Main Power LED remains illuminated when in standby mode.



NOTE:

The Standby mode characteristics can be configured by selecting **Power Options** from the Windows Control Panel menu.

2.1.8 Power Sources

Your VERUS Diagnostic Tool can receive power from any of the following sources:

- [Internal Battery Pack](#)
- [Charging Station \(Optional\)](#)
- [AC/DC Power Supply](#)
- [Data Link Connector \(DLC\), Standard Diagnostic Tool Only](#)

Internal Battery Pack

The VERUS Diagnostic Tool can be powered from a rechargeable lithium ion battery located on the bottom of the Diagnostic Tool under the right handgrip ([Figure 2-5](#)). A fully charged battery provides sufficient power for about four hours of constant operation.

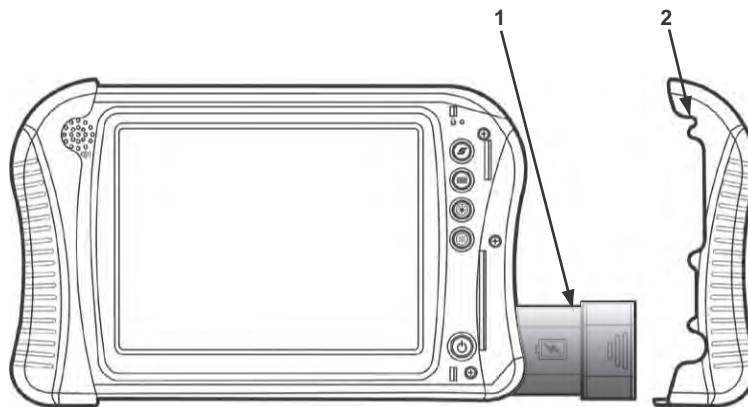

1— Internal Battery Pack

2— Right Handgrip

Figure 2-4 Battery pack location

The battery is recharged on demand whenever the Diagnostic Tool is placed in the optional docking station, or the AC/DC power supply is connected to a voltage source.

Charging Station (Optional)

The Diagnostic Tool can be powered and operated when installed on the optional charging station. The charging station also powers the internal battery pack charging process and allows USB connectivity for attaching peripherals. Contact your sales representative for additional details.

AC/DC Power Supply

The Diagnostic Tool can be powered from a wall socket using the AC/DC power supply and power cord. The AC/DC power supply also powers the internal battery pack charging process.

Data Link Connector (DLC), Standard Diagnostic Tool Only

The standard VERUS Diagnostic Tool can be powered through the DLC when connected to an OBD-II vehicle with the data cable. However, battery pack charging is not available when the Diagnostic Tool is being powered by the DLC.

2.2 Scan Module (United Kingdom Only)

The wireless Scan Module is provided as standard equipment on all EEMS325 VERUS Diagnostic Tools. Older VERUS Diagnostic Tools in the U.K., which are designed to operate with a hard-wired connection to the test vehicle, can also be converted to operate with the wireless Scan Module.

2.2.1 Functional Description

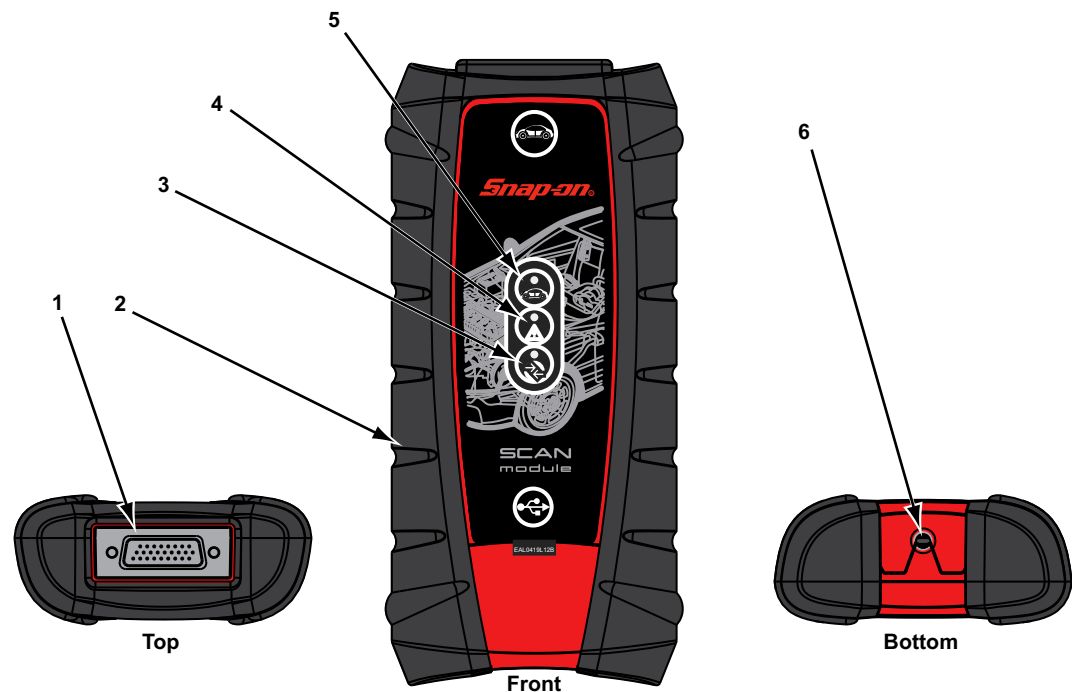

- 1— Data cable connector
- 2— Memory card port (remove protective hand grip for access)
- 3— Bluetooth LED (green)
- 4— Communication issue LED (red)
- 5— Vehicle power LED (green)
- 6— Universal serial bus (USB) jack (remove protective hand grip for access)

Figure 2-5 Scan Module

Wireless Communication

The Scan Module is a wireless communications device that transmits vehicle data to the VERUS Diagnostic Tool without a physical connection. The working range of the transmitter is about 30 feet (9.14 m). A signal lost due to moving out of range automatically restores itself when the display Diagnostic Tool is brought closer to the Scan Module. The Scan Module sounds a tone and the Diagnostic Tool shows a warning message when the signal is lost.

2.2.2 Technical Specifications

Communications:

Bluetooth 2.0 Class 1

Dimensions:

Length:

8.04 inches

204.3 mm

Height:

3.82 inches

97 mm

Depth:

1.66 inches

42.1 mm

Weight (including protective hand grip):

0.9 lbs.

0.408 kg

USB Power:

5V @ 500mA

Data Cable Connector Power:

8V to 32V, Maximum 12 Watts

Operating Temperature Range (ambient):

At 0 to 90% relative humidity (non-condensing)

32 to 113°F

0 to 45°C

Storage Temperature (ambient):

At 0 to 70% relative humidity (non-condensing)

-4 to 140°F

-20 to 60°C

Environmental Conditions:

This product is intended for indoor use only.

This product is rated for Pollution Degree 2 (normal conditions).

2.2.3 Power Sources

The Scan Module operates on 12-volt vehicle power, which it receives through the data cable connector. The Diagnostic Tool powers on whenever it is connected to an OBD-II compliant data link connector (DLC). For non OBD-II compliant vehicles, the Diagnostic Tool can be powered from a cigarette lighter or other suitable power port on the test vehicle using the optional auxiliary power cable.

Make sure the VERUS® Diagnostic Tool has a charged battery or is connected to an AC power supply (see “Power Sources” on page 10). It is recommended that you calibrate the touch screen on your VERUS Diagnostic Tool and upon initial startup, and as needed while the Diagnostic Tool is in service (see “Calibrating the Touch Screen” on page 134).

It is highly recommended that you back up personal and saved data to a USB mass storage device on a regular basis to prevent loss in the event of system corruption or hard disk drive failure.

3.1 Turning On

Press the Power button to turn the Diagnostic Tool on. The system boots up, then opens the VERUS Diagnostic Tool to the Home screen (Figure 3-1).













- 1— Function icons
- 2— VERUS Toolbar
- 3— Windows Toolbar

Figure 3-1 Sample VERUS Home screen

3.1.1 Function Icons

The Function icons configure the VERUS Diagnostic Tool for the type of test to be performed. The table below gives brief descriptions of the functions:

Table 3-1







Name	Icon	Description
Scanner		Configures the VERUS Diagnostic Tool to operate as a scan tool. See "Scanner Operations" on page 19.
OBD Direct		Allows you to perform generic OBD-II system tests without identifying the specific vehicle. See "OBD Direct" on page 58
Guided Component Tests		Opens a diagnostic database of specific tests for the identified vehicle. See "Guided Component Test" on page 66.
Scope Multimeter		Configures the VERUS Diagnostic Tool to operate as a lab scope, graphing multimeter, or digital multimeter. See "Scope Multimeter" on page 76.
Information		Provides the information needed to make repairs once you have made your diagnosis. The linked program varies by region. See "Information" on page 103.
Vehicle History		Opens a list of previously serviced vehicles. See "Vehicle History Operations" on page 115.
Data Manager		Opens the organization system for saved data files. See "Data Manager" on page 120.
Help		Opens the on-line help for the system. See "Help Operations" on page 128.
System Settings		Establishes and manages wireless communication between modules. See "System Settings Operations" on page 130.
Exit		Closes the VERUS Diagnostic Suite application. See "Turning Off" on page 18.

Use the touch screen to select the desired function.

3.1.2 VERUS Toolbar

Operation of the toolbar icons located on the lower-left area of the screen are described below:

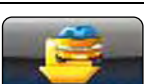
Table 3-2

Name	Icon	Description
Home		Touching this icon returns you to the VERUS Home screen from any test.
Desktop		Touching this icon opens and closes the standard Windows toolbars at the bottom of the screen.
Menu		Touching this icon opens a menu of common operations and information.
Change Vehicle		The currently identified vehicle is shown to the right of the icons, touching this icon allows you to change the identified test vehicle.
View Record		Touching this icon opens an editable worksheet of vehicle records.
Hardware Status		Indicates the connectivity status of the Scan Module.
		Indicates the connectivity status of the Scope/Multimeter.

Menu Options

The Menu on the Toolbar at the base of the display screen opens a list of basic operations and features. The list of options varies depending upon which module, or tool function, is active. Selecting a menu item opens a submenu of choices, and some submenus also open an additional menu. A right arrowhead (▶) indicates additional choices are available. Touch an item to select it. The following Menu options are available from the Home Screen:

- **Safety Information**—opens the *Important Safety Instructions* document.
- **Help**—allows you to view supporting documentation, selecting opens a submenu.

Safety Information is available for all of the modules, and Help, as explained below, displays in the SureTrack, Vehicle History, Data Manager, Help, and System Settings modules. Additional menu options are available for the Scanner, OBD Direct, Guided Component Test, and Scope Multimeter modules. These additional menu options are detailed in their respective module chapters.

Safety Information

Selecting Safety Information opens an electronic version of the printed *Important Safety Instructions* that were included with your Diagnostic Tool kit. The *Important Safety Instructions* document should be read and understood prior to using the Diagnostic Tool.

Help

A variety of utilities and additional resources are available through the Help menu. Basic menu options, which are available for all modules, include:

- [User Manual](#)
- [Version Info](#)
- [Activation Status](#)

User Manual

This option opens this document, which provides overall navigation and operation information for the Diagnostic Tool.

Version Info

This option opens a window showing the version of the VERUS software and the Software License Agreement (Figure 3-2). Select **OK** to close the window.

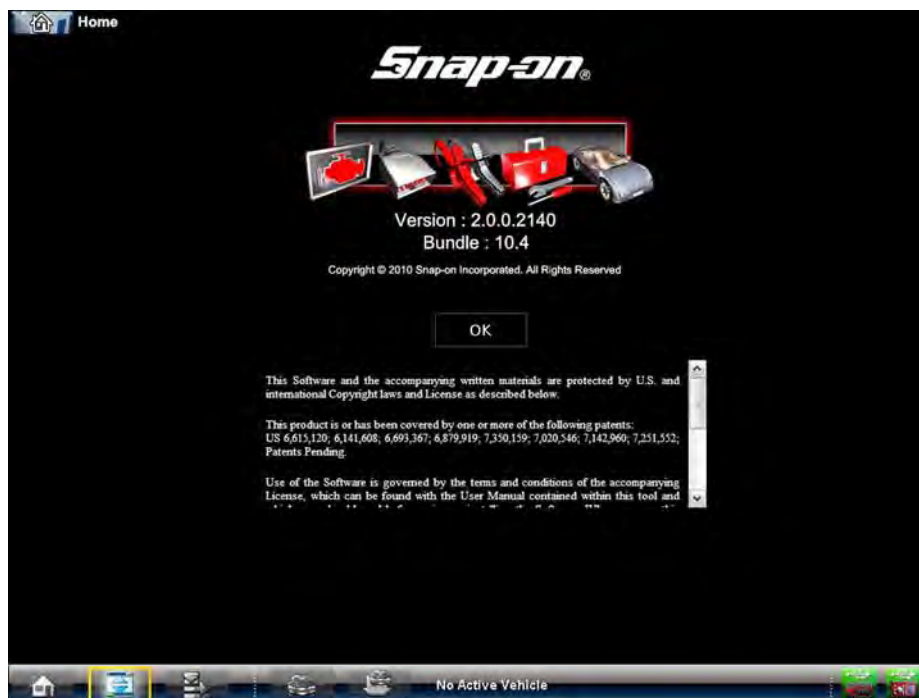

Figure 3-2 Sample software version screen

Activation Status

This option opens a dialog box with version and licensing details for the system, and activation status for the Diagnostic Tool and all other modules.

View Record

The year make and model of vehicle currently identified is shown on the toolbar. Touching the icon opens the worksheet, or service record, of the test vehicle (Figure 3-3).

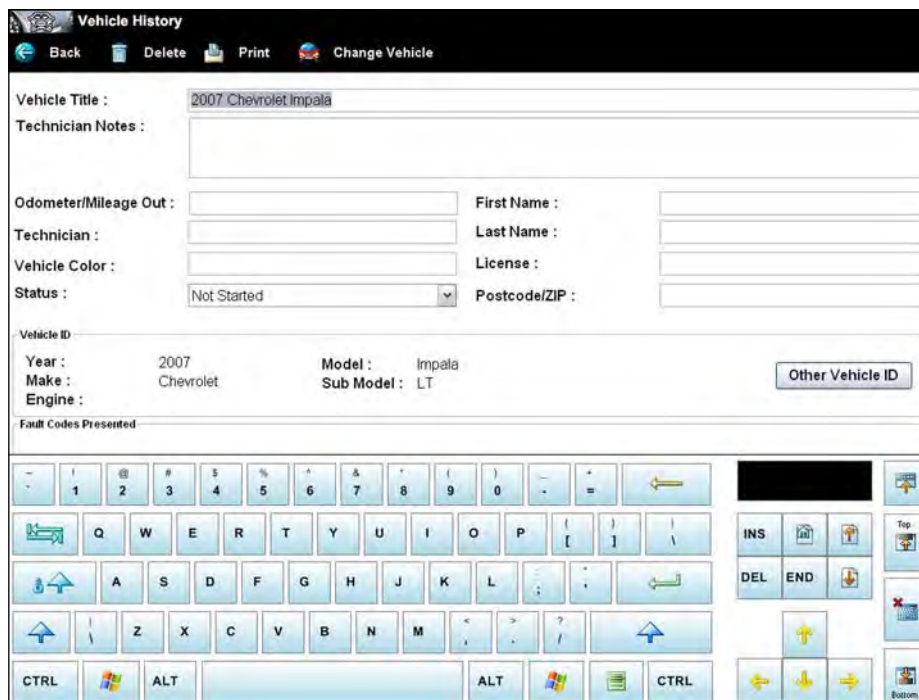

Figure 3-3 Sample vehicle worksheet

Use the virtual keyboard to enter data in the worksheet and select Back when finished. A toolbar at the top of the screen controls worksheet operations as explained in the table that follows:

Table 3-3 Worksheet toolbar icons (part 1 of 2)





Name	Icon	Description
Back		Touching this icon returns you to the previously viewed screen.
Print		Touching this icon sends the worksheet to a printer.
Attachments		Opens a window for attaching supplemental files, such as a screen capture or data printout, to the vehicle records.

Table 3-3 Worksheet toolbar icons (part 2 of 2)

Name	Icon	Description
Add		Displays once Attachments is selected, opens a search window for locating supplemental files.
View		Displays once Attachments is selected, opens an attached file.
Delete		Displays once Attachments is selected, removes an attached file.

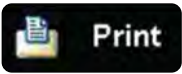
3.1.3 Windows Toolbar

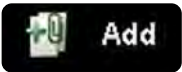
This is the standard Windows toolbar. Your VERUS Diagnostic Tool is a fully functional personal computer based on the Windows Embedded Standard operating system. Refer to Microsoft documentation for additional information.

3.2 Turning Off

All vehicle communication must be terminated before turning off the VERUS Diagnostic Tool. Failure to do so may lead to ECM problems on some vehicles. Always exit the Scan Module before turning off the VERUS Diagnostic Tool.



To turn off the VERUS Diagnostic Tool:

1. Open the Windows Start menu.
2. Select Turn Off Computer.
3. Select Turn Off in the dialog box.

The open programs close and the power switches off.

3.2.1 Emergency Shutdown

In case of emergency, press and hold the Power button to force a shutdown.

On early model (EEMS323) Diagnostic Tools, the Scanner is built into the Diagnostic Tool. On later-model Diagnostic Tools (EEMS325), the Scan Module is a stand-alone unit that communicates wirelessly with the VERUS Diagnostic Tool. Operation and function are similar for both the integral Scanner and the wireless Scan Module. The information in this chapter applies to both, unless otherwise specified.

The Scan Module is a stand-alone unit that communicates wirelessly with the VERUS Diagnostic Tool. The Scan Module allows you to establish a data link to the electronic control systems of the vehicle being serviced to retrieve diagnostic trouble codes (DTCs), view live data parameters, and perform tests. The Scan Module can access the electronic control module (ECM) for various vehicle control systems such as engine, transmission, antilock brake system (ABS) and more.

Testing requires connecting the Scan Module to the test vehicle using the data cable and test adapters. The Scan Module communicates wirelessly with the VERUS Diagnostic Tool. Instructions on the VERUS screen tell you how to connect the Scan Module. Additional connection information can be found in the appropriate vehicle communication software manual for the test vehicle, which is available through the Help menu.

4.1 Getting Started

Before initial use the Scan Module must be paired with the Diagnostic Tool to establish a communication link. Refer to [Pairing the Wireless Scan Module on page 131](#) for instructions and additional information.

The following steps get you started communicating with a vehicle:

1. Select the Scanner icon on the Home screen to start the Scan Module software
2. Follow the screen instructions to identify the test vehicle
3. Connect the VERUS Diagnostic Tool to the test vehicle with the data cable
4. Navigate through the Scan Module menus to begin testing

A demonstration program allows you to become familiar with Scan Module operations and testing without being connected to an actual vehicle.

4.1.1 The Demonstration Program

The Scan Module demonstration program allows you to become familiar with many of the test capabilities without connecting to a vehicle. Sample data and mock test results help you learn the menus and basic operations.

When applicable, both the Scan Module and the Diagnostic Tool must be powered on.



To start the demonstration program:

1. From the VERUS Home screen, select the **Scanner** icon.
The manufacturer menu displays. This menu includes all makes that are covered by any of the VERUS modules, not just those for which Scan Module information is available. A Demonstration icon that starts the program is also included in the list.
2. Select the **Demonstration** icon.

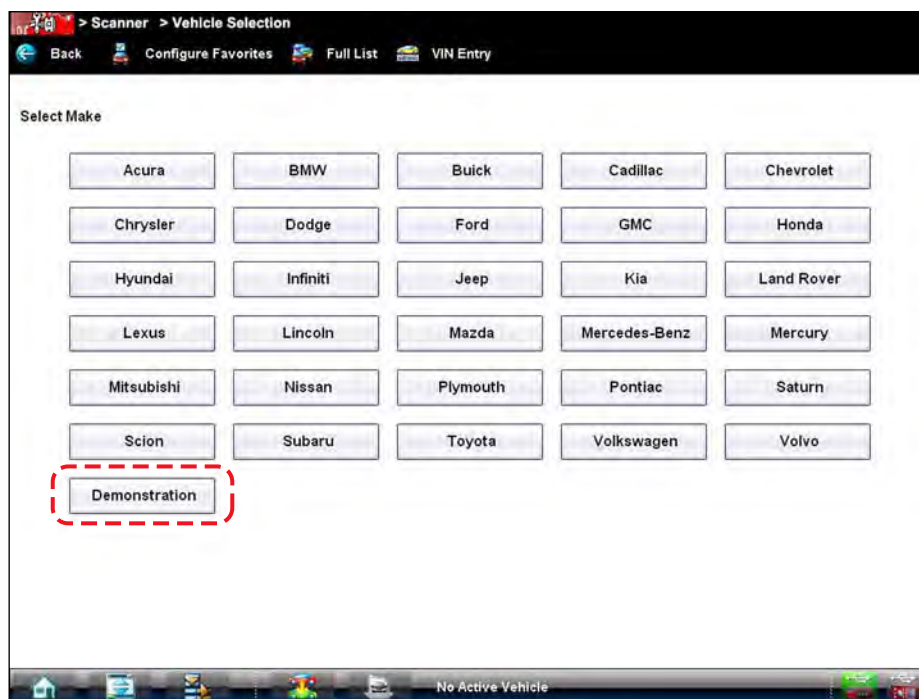

Figure 4-1 Sample demonstration selection

A screen with two choices now displays:

- Holden—contains simulated data for a Holden Commodore.
 - OBD Training Mode—provides simulated data for an OBD-II/EOBD vehicle that allows you to access any of the standard functions.
3. Select either option and a confirmation message displays.
 4. Select **OK** to load the selected database.
 5. Follow the on-screen instructions and select as needed until the Systems menu displays.
 6. Select from any of the systems listed, then select from the submenus.

IMPORTANT:

Do not connect a vehicle to the VERUS Diagnostic Tool while in the Demonstration mode.

4.1.2 Disconnecting the VERUS Diagnostic Tool From a Vehicle

When disconnecting the VERUS Diagnostic Tool from the vehicle, make sure the Scan Module software is not communicating with the vehicle.



To exit Scanner and disconnect the VERUS Diagnostic Tool from a vehicle:

1. From a codes or data display screen, select the **Exit** icon on the upper toolbar.

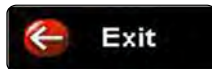

Figure 4-2 Sample upper toolbar Exit icon

The screen goes to the codes or data menu.

2. Select the **Back** icon on the upper toolbar.



Figure 4-3 Sample upper toolbar Back icon

The screen goes to the system menu.

3. Select the **Back** icon on the upper toolbar.
A “stopping communication” briefly displays followed by the systems menu.
4. Select the **Change Vehicle** icon on the VERUS toolbar.



Figure 4-4 Sample VERUS toolbar Change Vehicle icon

The vehicle description on the toolbar should now read “No Active Vehicle”.

5. Select the **Home** icon on the VERUS toolbar.



Figure 4-5 Sample Home icon

The Home screen displays.

6. Disconnect the test adapter from the vehicle connector.



NOTE:

Damage to the electronic control module (ECM) of the vehicle can occur if communication is disrupted. Ensure that the vehicle communication cable is properly connected at all times during testing. Exit testing before removing the test cable or turning off.

4.2 Vehicle Identification

The Scan Module information presented is provided by a direct link to the ECM of the vehicle being tested. Therefore, certain attributes of the test vehicle must be entered into the VERUS Diagnostic Tool so that the data displays correctly. Vehicle identification information is carried over if you enter the Scan Module either from the Guided Component Test module or from one of the records stored in the Vehicle History module. However, in some instances, you may need to enter additional attributes.

The vehicle identification sequence is menu driven, you simply follow the screen prompts and make a series of choices. Each selection you make advances you to the next screen. A Back icon in the upper left corner of the screen returns you to the previous screen. Exact procedures may vary somewhat by vehicle.



To identify a vehicle for Scan Module testing:

1. Select the **Scanner** Function icon from the Home screen.
A list of manufacturers displays (Figure 4-6).



Figure 4-6 Sample manufacturer list

2. Select the manufacturer of the test vehicle from the list.
A model year menu displays.
3. Select the year of the test vehicle from the menu.
A list of vehicle types or models displays.



NOTE:

Several selections may be required to properly identify the vehicle type and model, follow the screen prompts and enter the required information.

- A confirmation dialog box displays once all the required data has been entered.
4. From the Confirm vehicle details dialog box, select:
 - a. **Ok** to continue.
 - b. **Cancel** to return to the engine list.When Yes is selected list of systems available for testing on the identified vehicle displays.
 5. Select a test to continue (Figure 4-7).

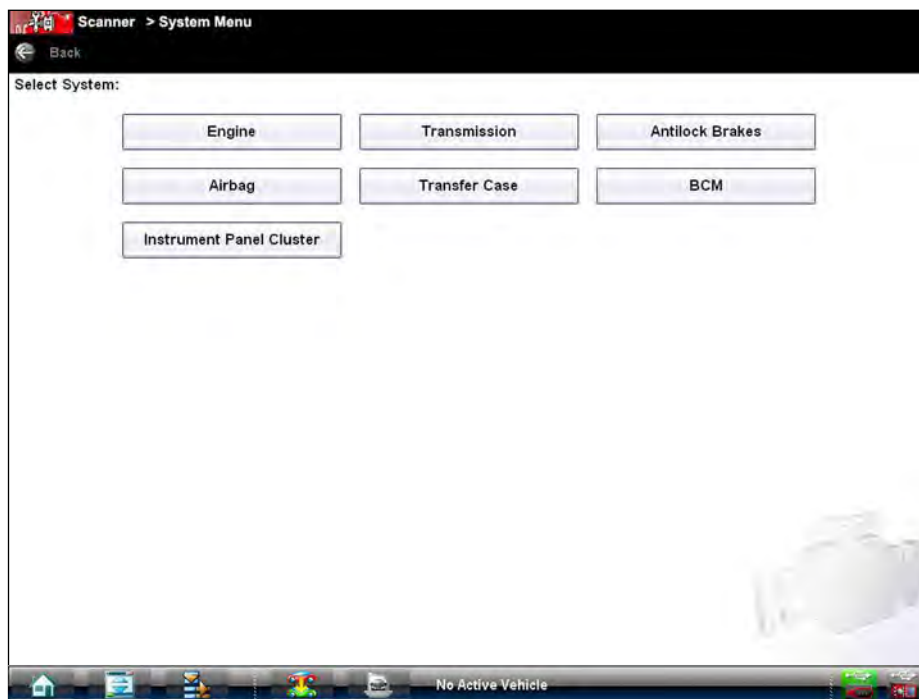

Figure 4-7 Sample available tests list

The identification sequence is now complete, refer to the Operations section that follows for details on how to navigate through the Scan Module data and perform tests.



NOTE:

If you return to the Home screen and select Guided Component Test the vehicle identification entered here is carried over. However, additional information may be needed in some instances.

4.2.1 Alternative Vehicle Identification

Occasionally, you may identify a test vehicle that the Scan Module does not recognize, the database does not support, or has some unique characteristics that prevent it from communicating with the Scan Module through the normal channels. In these instances, a menu of alternate choices that allow you to establish communication with the vehicle by other means displays. In addition to being able to identify a different manufacturer, the following alternative is available:

- OBDII/EOBD—allows you to perform generic OBD-II or EOBD tests, see [OBD Direct on page 58](#) for additional information.

4.2.2 Menu Options, Scanner

The Toolbar Menu at the base of the screen opens a menu near the top of the display.



Figure 4-8 Sample Scanner Menu options

The following Menu options are available:

- **Safety Information**—opens the *Important Safety Instructions* explained previously.
- **File**—allows you to print or save the data being viewed.
- **Tools**—allows you to perform certain maintenance operations and adjust tool settings.
- **Help**—allows you to view supporting documentation.

File

Use to print or save a copy of the data currently being viewed. Menu options include:

- **Save**—opens a submenu with these options:
 - **Screenshot**—saves a graphic image of the current screen.
 - **Collected Data**—saves a recording of all the data currently in the buffer plus the number of frames designated after the trigger event (see [Properties on page 49](#)).
 - **Print**—opens a submenu with these options:
 - **Screenshot**—sends the current screen image to a printer.
 - **Troubleshooter**—prints the full text of the troubleshooter topic shown in the main body.
- Selecting an option opens a Windows Print dialog box for printing or saving the file.

Tools

This option allows you to adjust tool settings to your personal preferences. Selecting Tools opens a menu with two options:

- [Units Setup](#)
- [Display BEN](#)

Units Setup

The units of measurement can be changed for temperature, vehicle speed, air pressure and other pressure readings. Choose between US standard or metric units of measure.

**NOTE:**

All measurement units return to their default values when different software is selected.

**To change the units setup:**

1. Select **Tools > Units Setup**.
The Measurement Units Setup dialog box opens.

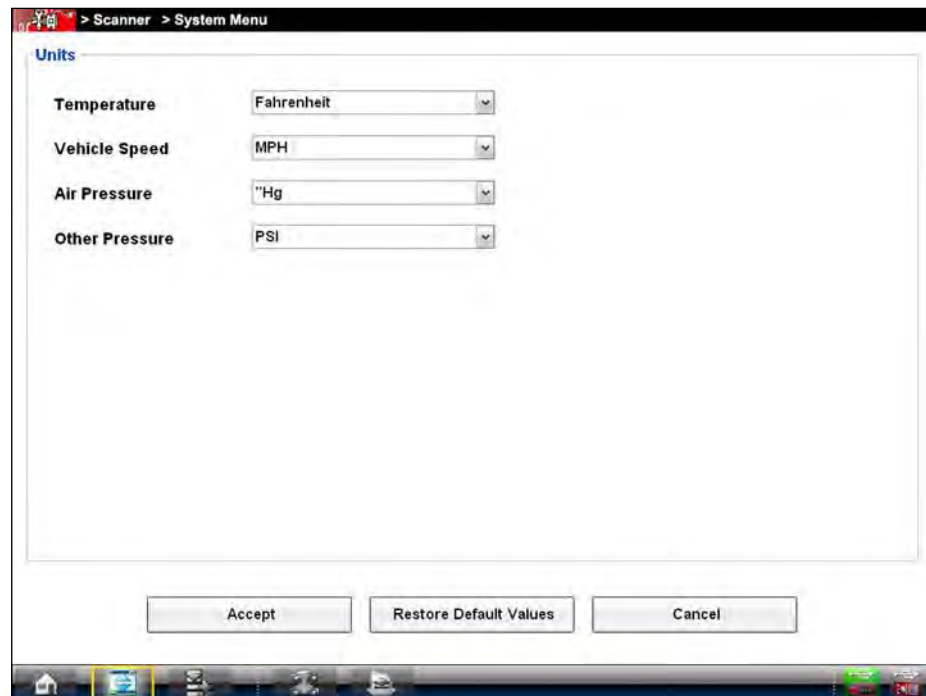

Figure 4-9 Sample Units Setup screen

2. Use the dropdown menus to select the desired value for each item.
3. Select **Accept** to close the dialog box and apply the changes.

Display BEN

Selecting opens a screen with the Balco Engine Number (BEN) of the currently identified vehicle. The BEN is used internally for data coordination, and you may be asked to provide this number to a Customer Care representative for troubleshooting communication problems.

Help

A variety of utilities and additional resources are available through the Help menu:

- [User Manual](#)
- [Version Info](#)
- [Activation Status](#)
- [User's Manuals](#)
- [About Scanner Hardware Version](#)
- [About Scanner](#)

The User Manual, Version Info, and Activation Status options are the same as explained previously, see [Menu Options on page 15](#) for details. Other options are explained below.

User's Manuals

This option opens a menu of additional support documentation, such as vehicle communication software manuals, available to assist in your diagnosis. These manuals provide connection information, detailed test procedures, and other resource material for specific vehicles.

Select **Exit** to close the Help module and return to the Scanner.

About Scanner Hardware Version

This option opens a dialog box showing the hardware version and other details about the Scanner module. A **Copy to Clipboard** icon allows you to paste the information to a document or e-mail.

About Scanner

This option opens a dialog box that shows the software version and other details about the Scanner module. A **Copy to Clipboard** icon allows you to paste the information to another document or e-mail.

4.3 Connecting to a Vehicle

Make a selection from the systems available for testing list and instructions for connecting the Scan Module to the vehicle with the data cable display on the screen. If an adapter and key are needed, the instructions tell you which ones to use, and also where to locate the vehicle diagnostic connector to perform the selected tests. Refer to the appropriate *Vehicle Communication Software Manual* for additional details.

4.3.1 Data Cable Connection

Connection of the data cable to the Diagnostic Tool and vehicle DLC is required for Scanner and OBD-II/EOBD testing.

Depending on the vehicle, the supplied DA-4 data cable may be used alone or may require optional adapters.

- **All OBD-II/EOBD compliant vehicles** - Use the supplied DA-4 data cable. The 26-pin end of the cable attaches to the data cable connector on the top of the Diagnostic Tool. The 16-pin end connects to the vehicle DLC. The cable connectors are secured with captive screws.
- **All non-OBD-II/EOBD (OBD-I) compliant vehicles** - Use the supplied DA-4 data cable with the optional DA-5 adapter and a manufacturer specific adapter. The 26-pin end of the cable attaches to the data cable connector on the top of the Diagnostic Tool. The 16-pin end connects to the DA-5 adapter, the DA-5 adapter connects to the manufacturer specific adapter and then connects to the vehicle DLC. The cable connectors are secured with captive screws.

On-screen cable and adapter connection instructions are provided while using the Scanner and OBD-II/EOBD functions. The instructions may also include the location of the vehicle DLC (Figure 4-10). If required, additional connection information can be found in the appropriate vehicle communication software manual for the vehicle. Vehicle communication software manuals are available online, see the website information at the front of this manual

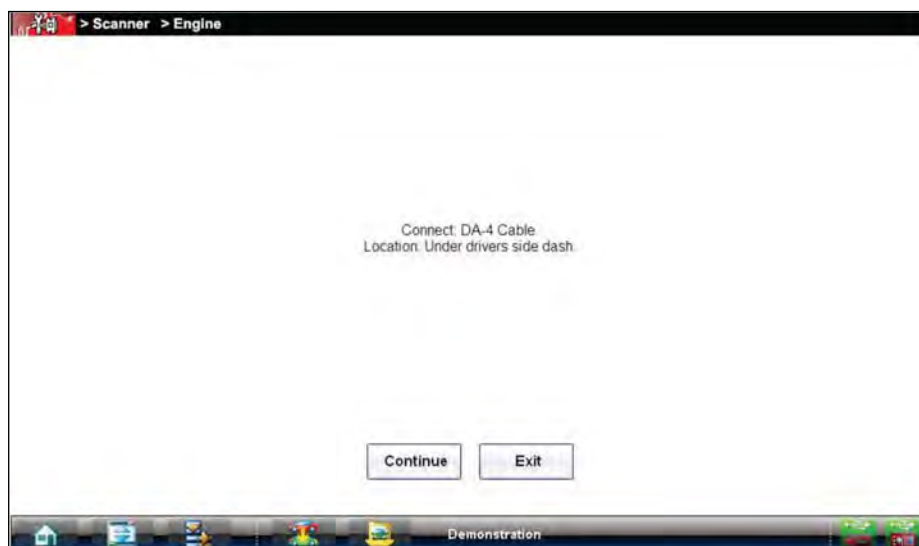

Figure 4-10 Vehicle connection data cable message

For data cable vehicle power connection information, see [Vehicle Power on page 6](#).

**To connect the data cable to the vehicle:**

1. Follow the on-screen instructions for connecting to the vehicle (Figure 4-10).
2. Select **Continue** once the data cable is connected.

The Diagnostic Tool establishes communication then displays a list of available tests. If the Diagnostic Tool is unable to establish a communications link, a “no communications” message displays.

3. Select from the available tests to open a submenu of test options.

4.3.2 No Communication Message

If the Scanner is unable to establish a communication link, a “no communication” message displays. A “no communication” message means the Scan Module and the vehicle electronic control module cannot communicate with each other for some reason.

The following conditions cause a “no communication” message to display:

- The Scanner is unable to establish a communication link with the vehicle.
- You selected a system for testing that the vehicle is not equipped with (such as ABS).
- There is a loose connection.
- There is a blown vehicle fuse.
- There is a wiring fault on the vehicle, or in the data cable or adapter.
- There is a circuit fault in the data cable, Personality Key, or adapter.
- Incorrect vehicle identification was entered.

Refer to the Vehicle Communication Software manuals for manufacturer-specific problems.

4.4 Navigation

This sections describes how to navigate the Scan Module interface and select scanner tests.

4.4.1 Scan Module Screen Layout

The Scan Module screens typically include three sections (Figure 4-11):









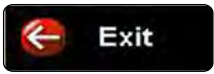
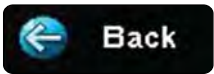

- 1— Scanner Toolbar
- 2— Main Body
- 3— Data Buffer Toolbar

Figure 4-11 Scan Module screen layout

Scanner Toolbar

The Scanner toolbar contains a number of icons that allow you to configure certain aspects of the displayed data and to exit. The table below provides a brief explanation of the Scanner toolbar icon operations:

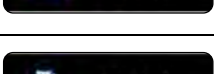
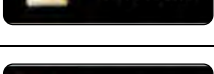
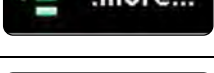
Table 4-1 Scanner toolbar icons

Name	Icon	Description
Exit		Closes the current test and returns you to the menu.
Back		Returns to the previously viewed screen.
Custom		Allows you to select which parameters are displayed on the screen.
Alarms		Allows you to set alarms on certain data parameters that sound a tone when the signal goes above or below the alarm setting.
Properties		Allows you to adjust the display characteristics for all of the data screens.
Graph View		Allows you to simultaneously view up to 16 data graphs at a time.
Save		Saves a copy of the current frame of data that can be viewed on the tool or in ShopStream Connect.
Print		Opens a standard Windows Print dialog box for saving a print copy of the current frame of data.
More		Opens a dropdown menu of the additional options shown below.
Scale		Switches the scale values, displayed along the left-hand side of the graphs, on and off.
Sweep		Switches the sweep values, displayed at the base of the graphs, on and off.

Main Body

The main body of the screen varies depending on the stage of operation. The main body can show vehicle identification selections, the main menu, test data, instructions, troubleshooting information, controls, and other diagnostic information.

Data Buffer Toolbar

Whenever communication is established with a vehicle, the Scan Module continuously records data transmitted by the ECM in the data buffer. The toolbar below the main body of the screen contains the icons for navigating this buffered data.

The slider in the middle of the toolbar with the stylus to quickly move through paused data.





Figure 4-12 Sample data buffer slider

Use the toolbar icons (Table 4-2) to more precisely navigate the data.

Table 4-2 Data buffer toolbar icons

Name	Icon	Description
Go To Start		Moves to the first frame in the data buffer
Pause		Suspends data capture and changes to show the Play icon
Play		Starts or resumes data capture and changes to show the Pause icon
Go To End		Moves to the last frame in the data buffer
Clear		Erases data in the data buffer
Step Back		Moves to the previous frame in the data buffer
Frame Counter		Indicates the data buffer frame currently displayed
Step Forward		Moves to the next frame in the data buffer
Snapshot		Arms the VERUS software to take a snapshot of vehicle data

Table 4-2 Data buffer toolbar icons

Name	Icon	Description
Zoom In		Increases the magnification by decreasing the sweep of the graph
Zoom Out		Decreases the magnification by increasing the sweep of the graph

4.4.2 Screen Messages

Screen messages appear when additional input is needed before proceeding. There are three types of on-screen messages; confirmations, warnings, and errors.

Confirmation Messages

Confirmation messages inform you when you are about to perform an action that cannot be reversed or when an action has been initiated and your confirmation is needed to continue.

When a user-response is not required to continue, the message displays briefly before automatically disappearing.

Warning Messages

Warning messages inform you when completing the selected action may result in an irreversible change or loss of data.

Error Messages

Error messages inform you when a system or procedural error has occurred.

Possible examples include a disconnected cable or a peripheral, such as a printer, is powered off.

4.4.3 Making Selections

The Scan Module software is a menu driven program that presents a series of choices one at a time. As you select from a menu, the next menu in the series displays. Each selection narrows the focus and leads to the desired test. Use the stylus or your fingertip to make menu selections.

4.5 Operations

The Scan Module allows you to establish a data link to the electronic control systems of the vehicle being serviced in order to view live data parameters and perform tests.

You can use selected functional tests, get troubleshooting tips, and get vehicle-specific trouble codes for various vehicle control systems such as engine, transmission, antilock brake system (ABS) and more.

The Scanner has two main functions:

1. **Scanner**—provides access to Vehicle Communication Software functions such as reading codes, viewing data, and performing functional tests.
2. **Fast-Track Troubleshooter**—provides the diagnostic power of Fast-Track Troubleshooter, a database of experience based information developed by master technicians.

After a system is selected and the Scan Module establishes communication with the vehicle, the Scan Module Main menu, which lists available tests, displays. Main menu options vary slightly by the year, make, and model of the test vehicle.

The main menu may include:

- **Data Display**— displays data parameter information from the vehicle electronic control module. selecting may open a submenu of viewing options.
- **Codes Menu**—displays diagnostic trouble code (DTC) records from the vehicle electronic control module. selecting may open a submenu of viewing options.
- **Clear Codes**—erases DTC records and other data from the ECM. This selection is found on a Codes submenu for some models.
- **Functional Tests**—provides specific subsystem and Guided Component Tests. The tests vary depending on the manufacturer and model.
- **Actuator Tests**—similar to functional tests, checks the operation of certain actuators, such as solenoid valves and relays.
- **Memory Resets**—allows you to reprogram adaptive values for certain components after making repairs. Selecting opens a submenu. These options are found on the Functional Tests Menu for some models.
- **System Tests**—provides specific subsystem testing. Performing these tests is similar to functional tests.
- **Generic Functions**—lets you access certain available Generic OBD II functions from a proprietary menu (1996 and newer vehicles only).
- **Troubleshooter**—provides step-by-step procedures, integrating parameter data and retrieving trouble codes when appropriate, for specific symptoms of the identified vehicle.

**To perform a Scan Module test**

1. **Start the Scanner**—Select Scanner on the VERUS Home screen.
2. **Identify the vehicle**—Identify the test vehicle by entering selecting from the menu options.
3. **Select the system**—Select the system to be tested (engine, transmission, ABS, Airbag, body) from the systems menu.
4. **Connect the data cable to the vehicle**—Follow the on-screen connection instructions to connect the VERUS Diagnostic Tool to the test vehicle.
5. **Select the test from the Scanner main menu**—Select the desired test.

4.5.1 Data Display

Depending upon the test vehicle, this selection may appear as Data, Data Display, Data Only, Data (No Codes), or something similar. All are the same, selecting has one of the following results:

- A submenu of data viewing choices displays.
- Vehicle data displays.

A submenu displays when more than one data viewing mode is available on the identified vehicle. On some models, the engine must be started or cranked before data can be displayed. For these models, a “Waiting to Communicate” message displays if the engine was not cranked or started.

Data Screens

When a Data selection is made, the screen displays the data list for the selected module. The items available for any electronic control module vary from one vehicle to another.

Data is presented in a 2-column format. An abbreviated parameter name is at the left of each column and its value is at the right edge of the column. Parameters display in the order that they are transmitted by the ECM, so expect variation between vehicles.

Gesture scrolling allows you to quickly move through the data list. Simply touch the screen and drag up or down to reposition the parameters being displayed. Position bars appear to the right of each column while scrolling to indicate the position of the current screen in relation to the entire list. Each column of parameters scrolls independently of the other column.

Parameters display in the order that they are transmitted by the ECM, so expect variation between vehicles. Figure 4-13 shows a typical data screen.

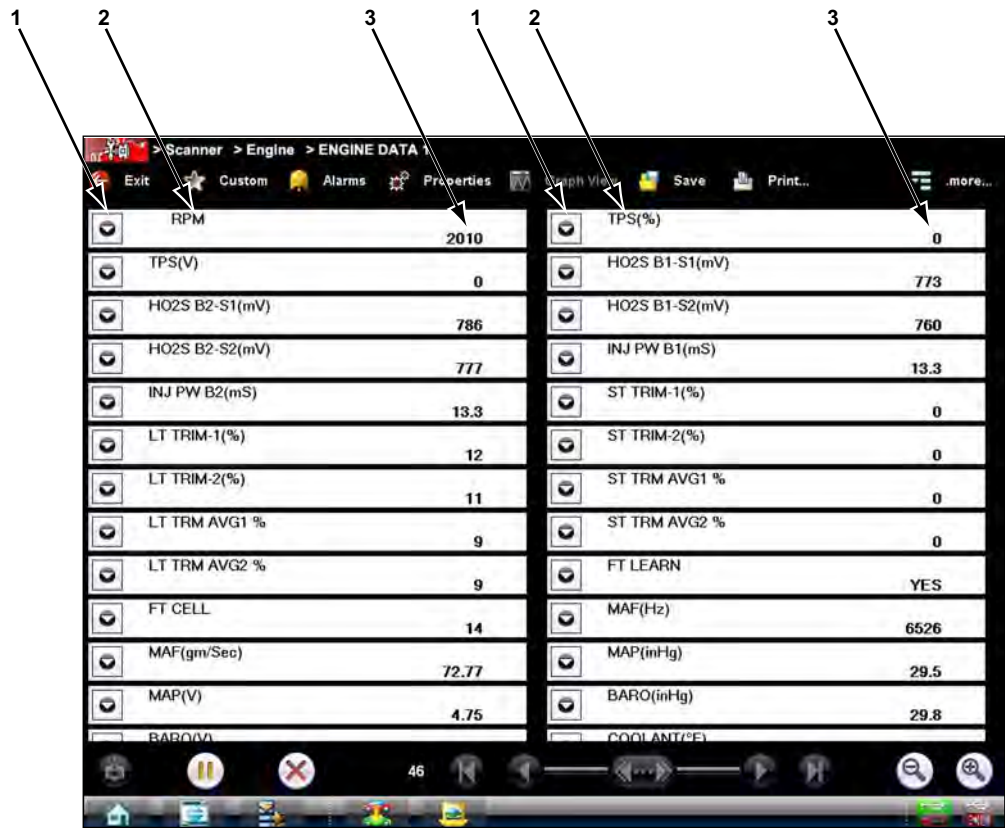

- 1— Graph icon
- 2— Parameter name
- 3— Parameter value

Figure 4-13 Sample data screen

Data Graphs

Select the **Graph** icon to open a data graph for that parameter (Figure 4-14). Selecting a parameter for graph view moves it to the top of the list. Select the **Graph** icon again to close the graph for that parameter and return to a data list view.

You can view up to six graphs at a time on the standard VERUS screen, and up to sixteen graphs at a time when Graph View is selected from the toolbar. Refer to [Graph View on page 50](#) for additional information.

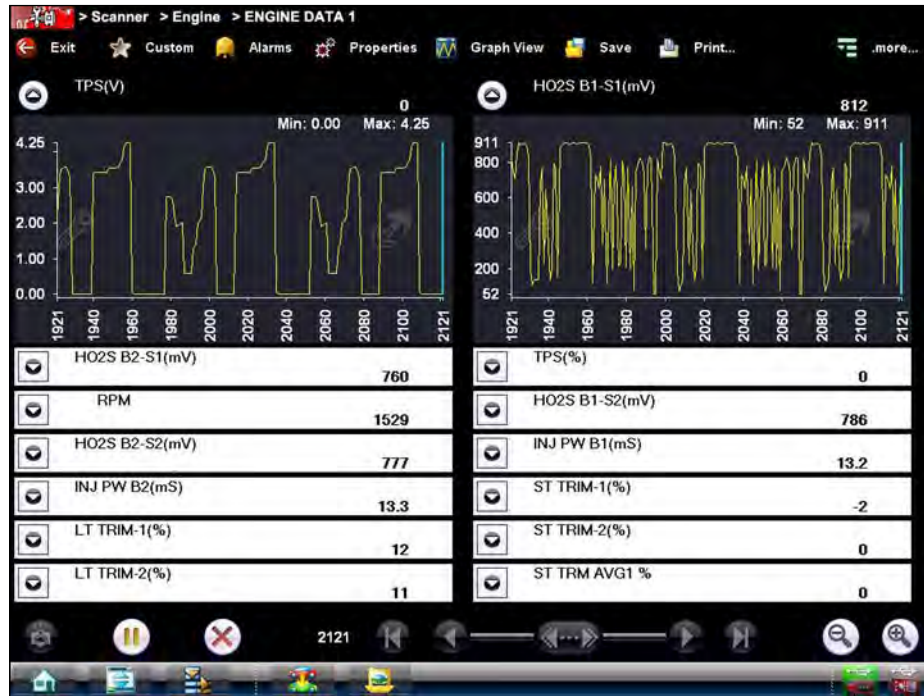



Figure 4-14 Sample data graph display

The two icons display on each data graph allow you configure settings for the selected graph only:

Table 4-3 Data graph icon operations

Name	Icon	Description
Expand/Collapse		Select to expand the graph to fill the entire screen, tap again to collapse the graph to the standard view.
Graph Properties		Select to open the Graph Properties dialog box, which allows you to set triggers for recording a snapshot and adjust the scale.

Triggers

Triggers establish threshold values, an upper limit and a lower limit, for recording a data snapshot. A snapshot allows you to closely evaluate conditions that caused the triggering event.

When a snapshot is taken, the Scanner captures additional data after the trigger point is detected, data collection pauses, and the buffered information is automatically saved as a movie. This gives you a complete picture of what was happening before the fact, what occurred at the trigger point, and what happened after the fact.

Data collection is paused following a trigger event. Select the **Play** icon to resume viewing live data. A vertical line now appears on each of the data graphs to indicate the triggering point. The trigger line on the parameter that triggered the snapshot is a different color than those on the other graphs. This makes it easy to determine which parameter caused the trigger when triggers are set for multiple parameters.



To adjust the amount of data collected after a trigger:

1. Select the **Properties** icon on the Scanner toolbar to open the dialog box.
2. Highlight one of the **Samples After Trigger** options.
3. Select the Accept icon to close the dialog box.



NOTE:

You can also adjust the amount of data collected after a triggering event using the Properties icon on the Scanner toolbar. See [Properties on page 49](#) for additional information.



To set triggers and record a snapshot:

1. Select the Graph Properties icon on the parameter graph you wish to set triggers on to open the dialog box.
2. From the Graph Properties dialog box, Select **Triggers On**.

A check mark appears in the box and the minimum and maximum fields activate (Figure 4-15).

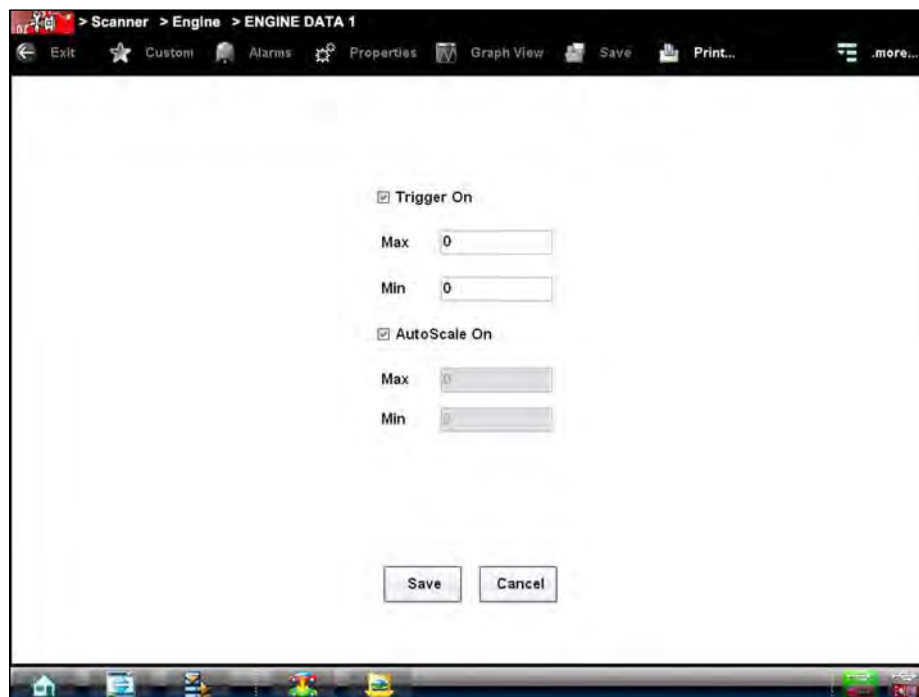

Figure 4-15 Sample Graph Properties dialog box

3. Select either **Max:** (maximum) or **Min:** (minimum) to activate that field and open the virtual keyboard.
4. Type the desired trigger value into the field.
5. Select the other field and enter a trigger value, then close the virtual keyboard.
6. Select **Accept** to close the dialog box.

Trigger lines (blue for upper and red for lower) display on the selected parameter graph.

The area between the upper and lower trigger lines establishes the triggering condition. Once the snapshot is armed, any data points that register outside of the set trigger conditions initiates a snapshot. The Scan Module continues to record the preset amount of data after the trigger and includes it in the snapshot.

7. Select **Snapshot** on the Data Buffer Toolbar to arm the snapshot.

The Snapshot icon changes color to indicate it has been armed (Figure 4-16).



Figure 4-16 Sample armed Snapshot icon

Once all of the data is compiled, data collection pauses and the information is saved as a movie. A confirmation screen displays to let you know the name automatically assigned to the saved file and where to locate it.



Figure 4-17 Sample saved movie confirmation screen

8. Select **OK** to close the confirmation screen.
9. Select the **Play** icon on the toolbar to resume viewing live data.



NOTE:

Selecting an armed Snapshot icon disarms it.

Scale

Scale adjusts the upper and lower values displayed on the vertical axis of a data graph. Two scale modes are available; auto scale and manual scale. Auto scale, which is the default setting, automatically adjusts the graph scale based upon the minimum and maximum values transmitted by the ECM. Manual scale allows you to set the minimum and maximum values.



To manually set the scale on a graph:

1. Select the Graph Properties icon on the graph you wish to scale to open the dialog box.
2. From the Graph Properties dialog box, select **Auto Scale On**.

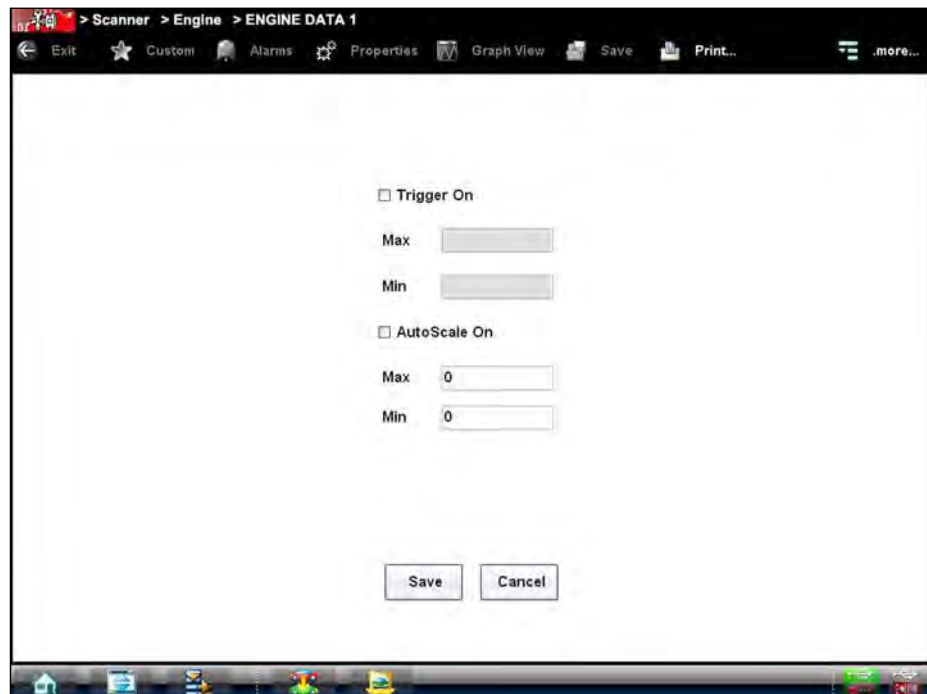

Figure 4-18 Sample manual scale selection

- The check mark is cleared from the box and the minimum and maximum fields activate
3. Select either **Max:** (maximum) or **Min:** (minimum) to activate that field and open the virtual keyboard.
 4. Type the desired trigger value into the field.
 5. Select the other field and enter a trigger value, then close the virtual keyboard.
 6. Select **Save** to close the dialog box.

The dialog box closes and the parameter scale is now at the set values.

Using Zoom

The zoom options Data Buffer toolbar allow you to change the level of magnification of the sweep when viewing graph data. Use the Zoom In (+) icon to increase magnification, and the Zoom Out (-) icon to decrease magnification.

4.5.2 Codes Menu

This selection may appear as Codes, Codes Menu, Codes Only, codes (No Data), or something similar on the menu. Selecting opens a list of data parameter viewing options that may include:

- Display Codes
- Clear Codes
- Freeze Frame/Failure Records
- DTC Status

Display Codes

Selecting either opens a list of diagnostic trouble codes (DTCs) stored in the selected electronic control module (ECM), or a submenu of DTC viewing options. Submenu options include:

- **Trouble Code Information**—opens a list of codes in ECM memory.
- **History Codes**—opens a list of codes whose symptoms are not currently present. History codes indicate an intermittently occurring problem.
- **Failed This Ignition**—opens a list of codes that set during the current ignition cycle.
- **MIL SVS or Message Requested**—displays ECM requests to light the malfunction indicator lamp (MIL) or service vehicle soon (SVS) lamp, or display a driver information alert.
- **Last Test Failed**—displays a complete list of failed tests.
- **Test Failed Since Code Cleared**—displays a list failed tests that failed since the last time codes were cleared from ECM memory.

A code list includes the DTC and a brief description (Figure 4-19).

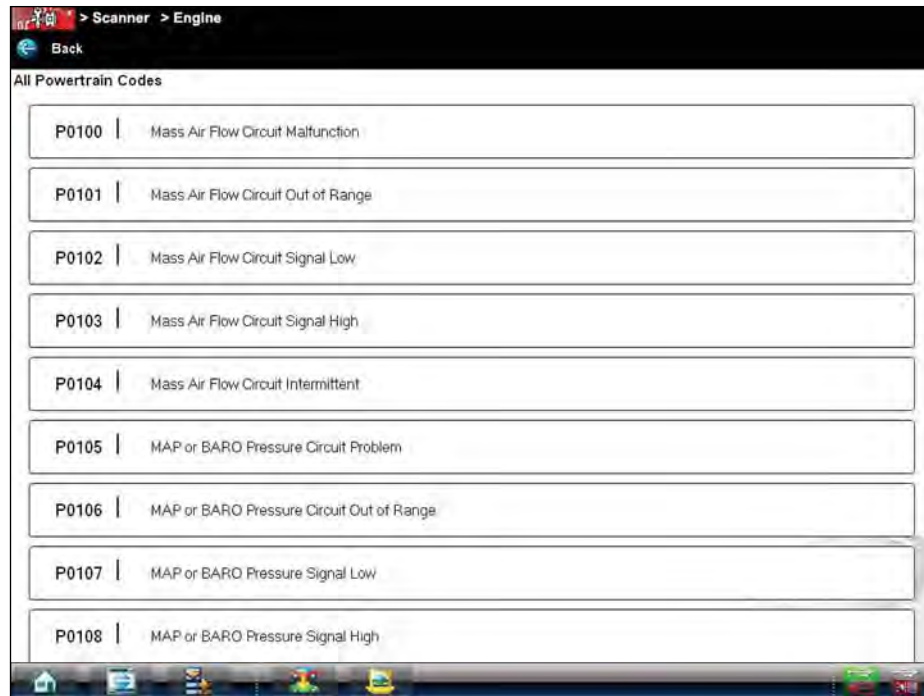

Figure 4-19 Sample code list

Clear Codes

The Scan Module clears trouble codes from the electronic control module memory on some vehicles. If this function is not available on the test vehicle, Clear Codes does not appear as a menu option.



To clear codes:

1. Select **Clear Codes** from the Codes Menu.
A confirmation message displays.
2. Make sure any conditions shown on the confirmation message are met, then select **Yes**.
A “codes cleared” message displays once the operation is complete.
3. Select **Continue** to return to the Codes Menu.

Freeze Frame/Failure Records

This selection displays the DTC that was set, along with corresponding data, when the ECM commanded the malfunction indicator lamp (MIL) to turn on.

DTC Status

This selection allows you to view the records of a particular DTC.



To check DTC status

1. Select **DTC Status** from the Codes Menu.

The DTC Status entry field displays and the virtual keyboard opens ([Figure 4-20](#)).

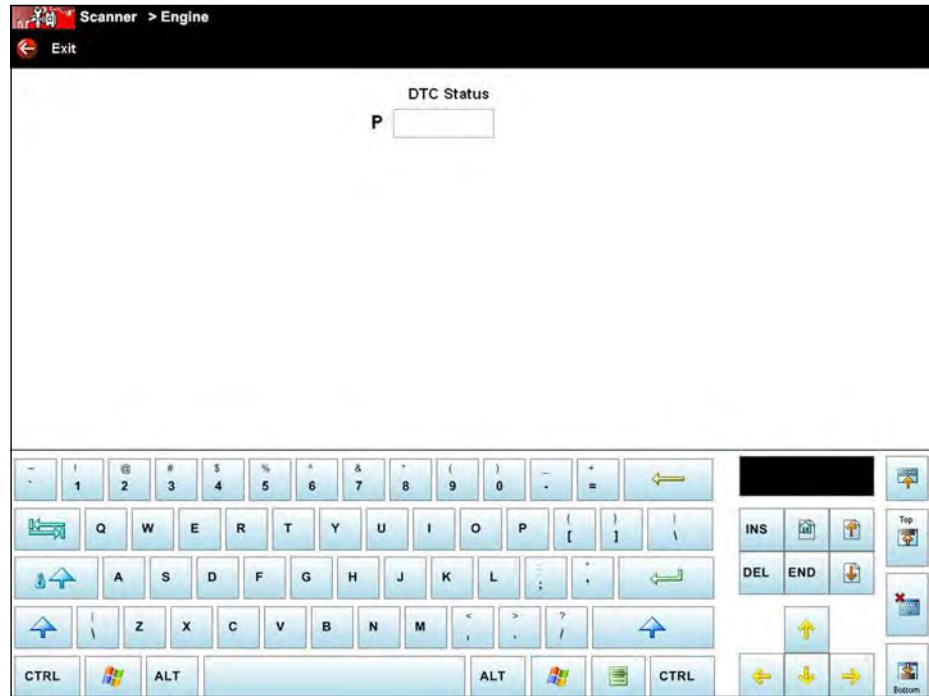

Figure 4-20 Sample DTC Status entry field

2. Use the virtual keyboard to enter the characters of code.
3. Select the virtual keyboard **Backspace** icon if needed to erase a character.

4. Select the virtual keyboard **Return** key once all the code characters are entered. The DTC status report displays (Figure 4-21).

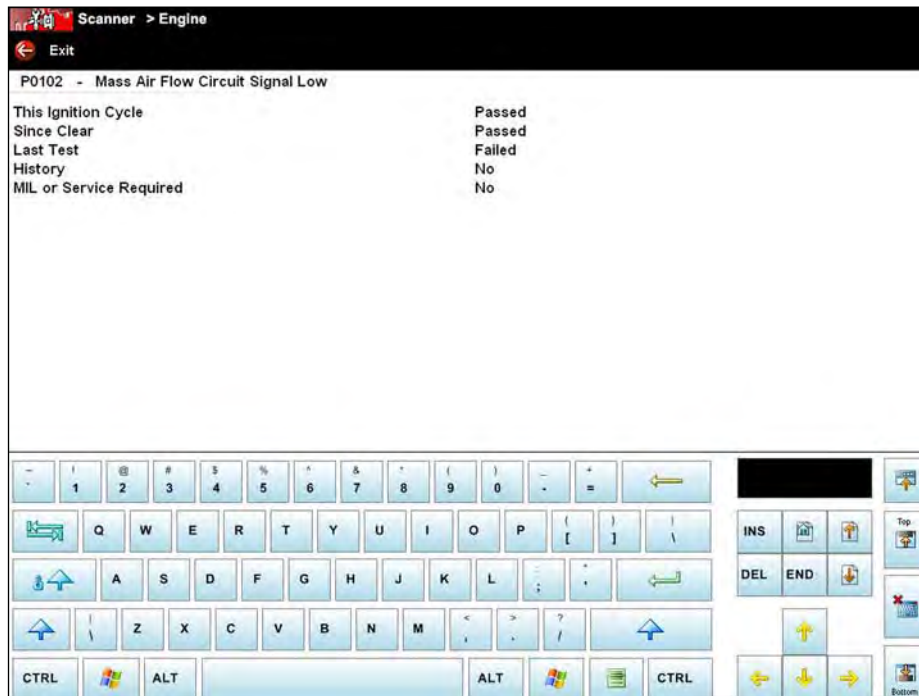

Figure 4-21 Sample DTC status report

5. Select **Exit** to return to the DTC status entry screen.
6. Select **Exit** again to return to the Codes menu.

4.5.3 Functional Tests

The **Functional Tests** selection is used to access vehicle-specific subsystem and guided component tests. Available tests vary by manufacturer, year, and model, and only the available tests display in the menu. There are four general types of functional test operations:

- **Information Tests**—are read-only tests, like selecting “VIN” from a Functional Tests menu to display the VIN of the identified vehicle.
- **Toggle Tests**—switch a component, such as a solenoid, relay, or switch, between two operating states.
- **Variable Control Tests**—command a certain value for a system or component, such as varying the spark timing in 1° increments or the EGR valve duty cycle in 10% increments.
- **Reset Tests**—reset the adaptive, or learned, values that are stored in the electronic control module.

Selecting Functional Tests opens a menu of test options that varies by make and model. Selecting a menu option either activates the test or opens a submenu of additional choices. Follow all screen instructions while performing tests. How and what information is presented on the screen varies according to the type of test being performed.

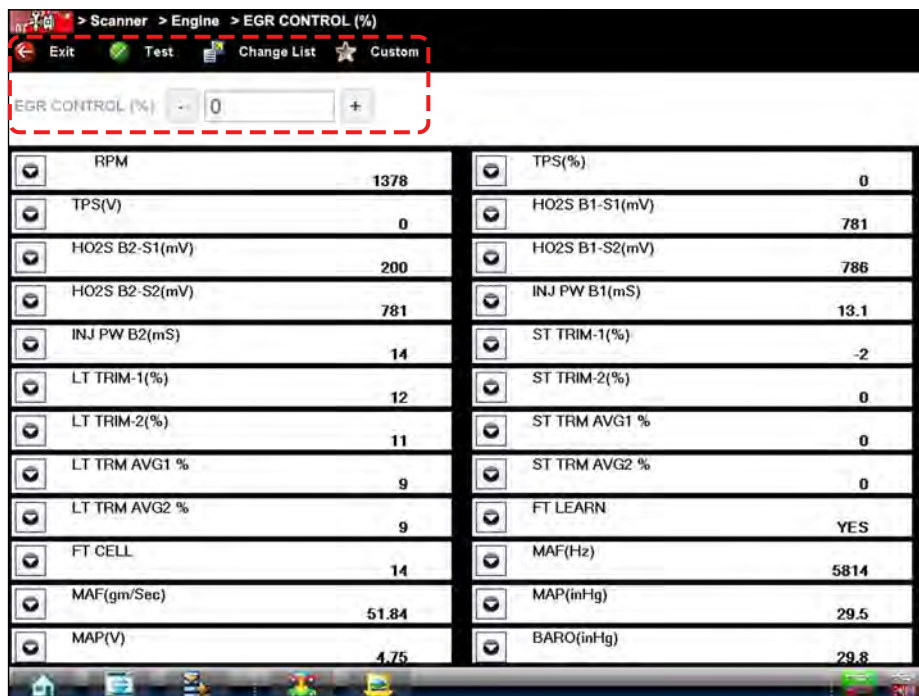



Figure 4-22 Sample functional test controls

Some toggle and variable control tests display functional test controls at the top of the screen with data stream information below (Figure 4-22). Functional test controls allow you manipulate the test signal as shown in Table 4-4.

Table 4-4 Functional test control icons (sheet 1 of 2)

Name	Icon	Description
Test		Activates the test.
Return		Moves focus back to the data list.
Change List		Allows you to switch data lists.
Custom		Allows you to select which parameters display during the functional test.
On		Switches an item high or on.
Off		Switches an item low or off.

Table 4-4 Functional test control icons (sheet 2 of 2)

Name	Icon	Description
Minus		Incrementally reduces a variable signal.
Plus		Incrementally increases a variable signal.

4.5.4 Generic Functions

The **Generic Functions** selection opens a menu of available OBD-II/EOBD functions on 1996 and newer vehicles. Menu options typically include:

- Readiness Monitors—displays the status of the OBD-II/EOBD required monitors
- (\$02) Freeze Frame—displays data stored in ECM memory when a DTC is set
- (\$05) Oxygen Sensor Monitoring—displays on-board oxygen sensor monitoring test results
- (\$06) Non-Continuous Monitors—displays the status of system monitors
- (\$08) Request Control of On-Board System—establishes bidirectional ECM communication
- (\$09) Calibration Identification—displays the ECM calibration identification numbers
- (\$09) Calibration Verification Number—displays the ECM calibration
- (\$09) In-Use Performance Tracking—displays a monitoring conditions report
- (\$09) Vehicle Identification Number—displays the VIN

Refer to the *Global OBD Vehicle Communications Software Manual* for additional information.

4.5.5 Scanner Toolbar Operations

The Scanner toolbar is used to configure certain aspects of the displayed data and to exit. The following sections explain how to use the toolbar.

Custom

The **Custom** icon on the Scanner Toolbar is used to determine which specific parameters display. Minimizing the number of parameters on the data list allows you to focus on any suspicious or symptom-specific data parameters. You can add or remove most parameters from the list. Any parameter that has a lock icon next to it cannot be removed from the list.

IMPORTANT:

Limiting the number of parameters to display only those that apply to a particular situation allows for a faster refresh rate of the data. A smaller data lists also reduces the amount of memory used for saved files.



To create a custom data list:

1. Select **Custom** on the Scanner Toolbar.

The parameter selection dialog box with all of the parameters selected opens (Figure 4-23).

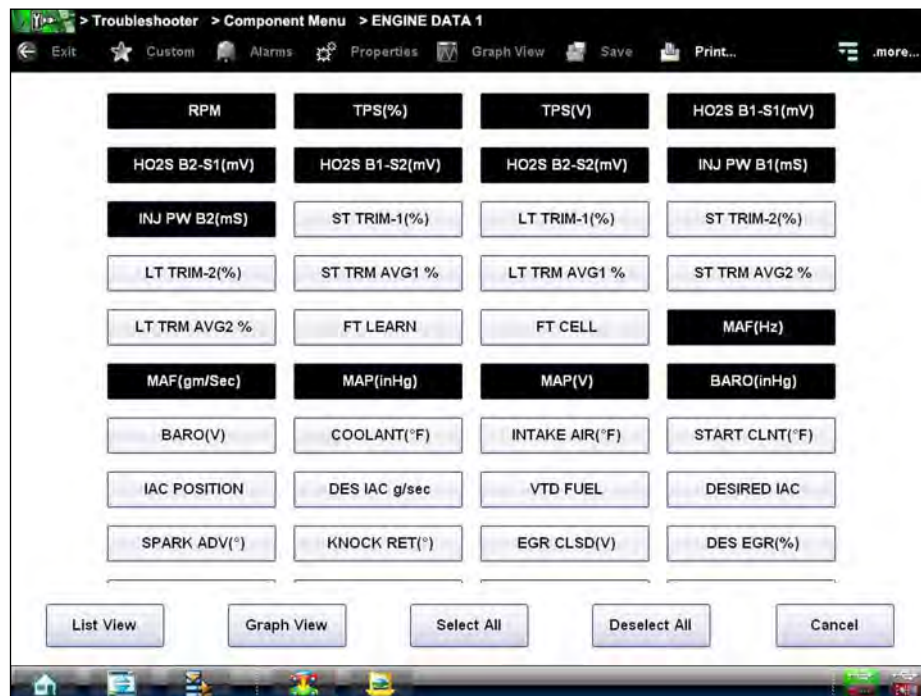

Figure 4-23 Sample custom list configuration screen

2. Select the **Deselect All** icon to clear the highlights from the screen.
3. Create a custom data list by selecting the parameters to be included. Highlighting indicates a parameter that displays, parameters that are not highlighted do not display.

Keep the following in mind when configuring a custom data list:

- A scroll indicator at the right of the screen shows if the list of parameters is longer than what is shown on the screen. Touch and drag up anywhere on the screen to bring the additional parameters into view.
 - Use the **Select All** icon to display the complete list.
 - Use the **Deselect All** icon to remove all the currently selected parameters from the list.
 - Select individual parameters to highlight and include them in the list.
 - Select individual highlighted parameters to remove them from the list.
 - Use the **Cancel** icon to return to the data display.
4. Once all desired parameters have been selected, return to the data list:
 - Use the **List View** icon to return to a data screen in PID List format.
 - Use the **Graph View** icon to return to a data screen in Graph format.



NOTE:

Graph View is only available when 16 or fewer parameters (the number that can display on a single screen) have been selected for the custom list. Check to make sure that no more than 16 parameters are highlighted if the screen does not switch to the data list when the Graph View icon is selected.

Alarms

Alarms are visual indicators next to a parameter in the data display list that change color to show the status of the signal. A green alarm indicates on, a gray alarm indicates off. Only parameters with a range of two states, can have alarms. Parameters with continuous ranges, such as variable voltage and pressure values, cannot have alarms.

The **Alarms** selection is used to configure visual indicators on certain digital data parameters. If a vehicle does not provide signals for these functions, the alarm indicators are unused.

The alarm indicator assignments remain as selected until you exit the data list:



To configure alarm settings:

1. Select the **Alarms** icon on the Scanner Toolbar.
The Alarm List dialog box opens.



NOTE:

Alarms can only be set for certain parameters. If the Alarm List dialog box is empty, no parameters are available and no alarms can be set.

2. Check the parameters that you want to show alarms.
3. Select **Save List**.

Alarm indicators now appear next to the selected parameters in the Data List. The indicators, which display in both text and graph views, are green when the value is high, and gray when the value is low (Figure 4-24).



Figure 4-24 Sample alarm indicators

Properties

The **Properties** icon on the Scanner Toolbar is used to configure certain characteristics of the parameter graph display. Selecting opens a Properties dialog box that allows you to adjust colors, settings, and sweep (Figure 4-25).

Selecting either color option, **Edit Background Color** or **Edit Plot Color**, opens a standard color picker dialog box. Select a color, then select OK to close the dialog box.

Setting options let you choose whether to display a grid on the data graphs and how many data samples are recorded following a triggering event. The grid displays if the box is checked, and the highlighted samples icon indicates the number of frames that record after a trigger.

The scales options let you choose the sweep, or the amount of time between division, of the data graphs. Values are in milliseconds.



Figure 4-25 Sample properties dialog box

Graph View

The Graph View icon on the Scanner toolbar allows you to simultaneously view up to sixteen data graphs. Select the Graph View icon and all of the parameters that were being viewed as data graphs in the standard mode now display together on the screen. Only the previously opened graphs display. If ten data graphs are open before Graph View is selected, ten graphs display on the screen once the icon is pressed (Figure 4-26).



Figure 4-26 Sample Graph View screen

The Expand/Collapse and Graph Properties features are not available in Graph View, and Scanner toolbar functions are limited to switching the Sweep and Scale information off and on. The Data Buffer toolbar remains active, and any triggers set prior to entering Graph View remain applicable.



To use Graph View:

1. Open the graph for each data parameter, up to sixteen, that you wish to view.



NOTE:

Use Custom Setup from the Scanner toolbar to minimize the data list to only those parameters you want to view and reduce setup time. With the minimal data list there is no need to scroll and select parameters, you simply open all of them on the list. See [Custom on page 46](#) for details on how to create a custom data list.

2. Configure parameter settings, such as Triggers, Auto Scale, and Sweep, as needed. Remember, these must be selected before entering Graph View.
3. Select **Graph View** on the Scanner toolbar.
All of the open data graphs now appear on a single screen (Figure 4-26).
4. Select **Back** on the Scanner toolbar to return to a normal view.

Save

The **Save** icon is used to record movies of vehicle datastream values. Saved files can be helpful when trying to isolate an intermittent problem or to verify a repair during a road test.



To save a movie:

- Select **Save**.

A save movie dialog box displays while data is being saved. The movie is saved when the message box disappears.



Figure 4-27 Sample save dialog box

Saved files can later be viewed by selecting Data Manager on the home screen. From the Data Manager open the Scanner Data Folder, then locate and select the saved file to be viewed.

Print

Selecting Print from the toolbar opens a standard Windows Print dialog box. Select from the options as needed to print the current frame of data.

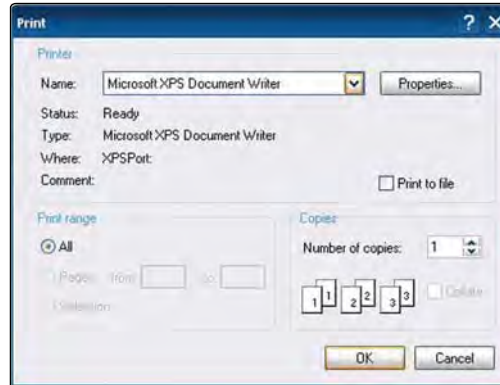

Figure 4-28 Sample print dialog box

If the Diagnostic Tool is connected to a printer, the current frame of data is printed. If the Diagnostic Tool is not connected to a printer, the frame of data is saved as an “XPS” file. A dialog box opens so that you can name the print file and specify the location that it is saved to.

Saved files can be printed at a later date, or opened and reviewed.



NOTE:

Saved print files cannot be viewed using the Data Manager, they can only be opened into an internet browser.



To open a saved print file:

1. Minimize the Diagnostic Suite to view the desktop.
2. From the desktop select **My Documents > ShopStream > Scanner Data Folder**.
3. Locate the file you wish to view.
4. Double click the file to open it.

The internet browser opens and the file opens.

More

Whenever the More icon appears on the toolbar it indicates that there are additional options available. Selecting the More icon from the Scanner toolbar opens a dropdown menu that offers two choices, Scane and Sweep, that only apply to data graphs:

Scale

The Scale option switches the scale values, displayed along the left-hand side of the graphs, on and off (Figure 4-29). The dropdown menu closes once a selection is made.

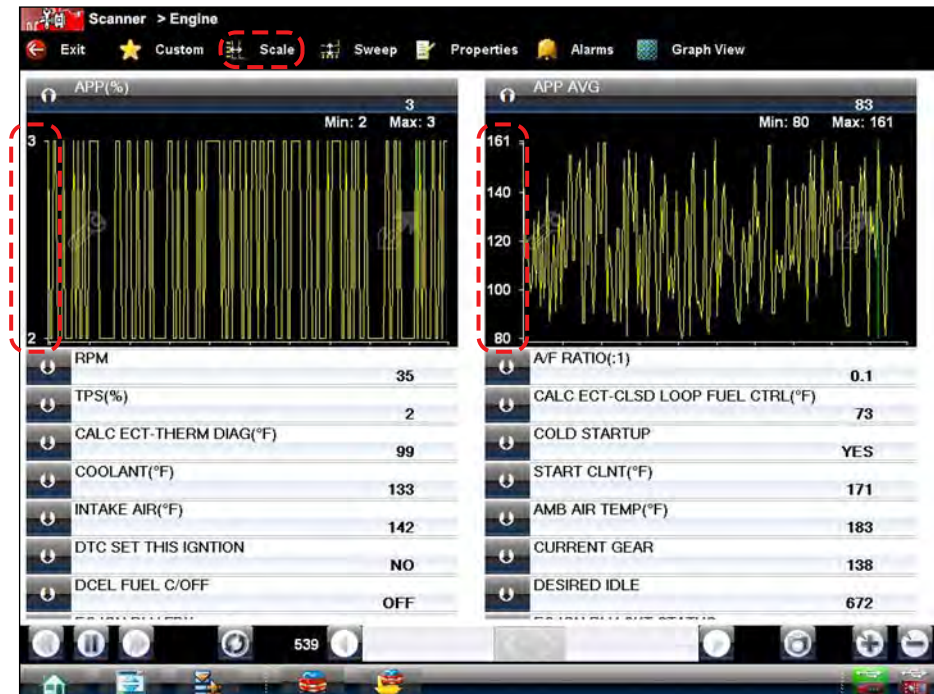

Figure 4-29 Sample Scale values displayed

Sweep

The **Sweep** option switches the sweep values, displayed below the graphs, on and off (Figure 4-30). The dropdown menu closes once a selection is made.

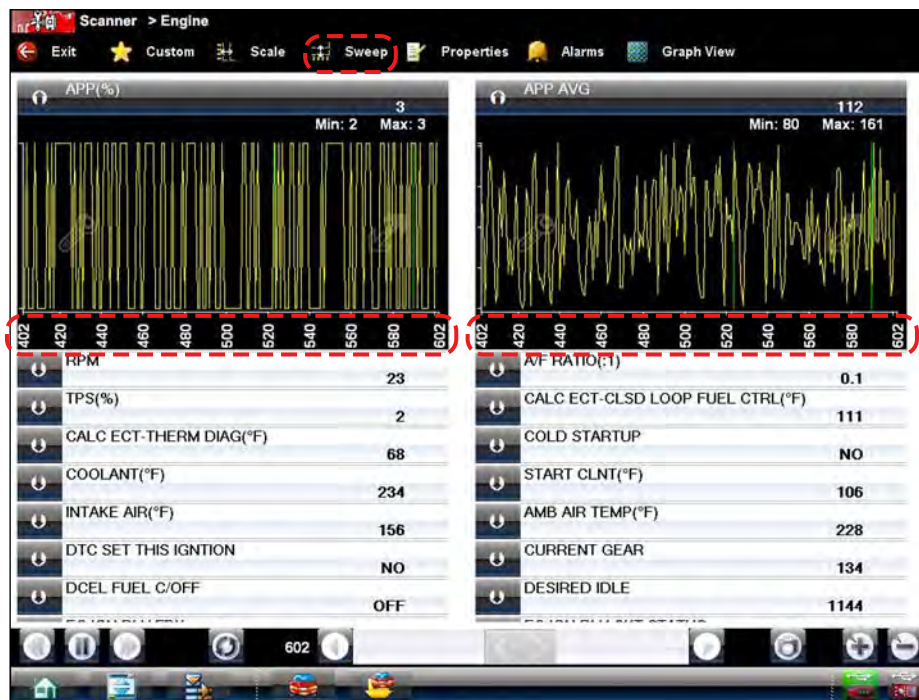

Figure 4-30 Sample Sweep values displayed

4.6 Exiting the Scanner

The Scan Module remains open as long as there is an active communication link with the vehicle. You must disconnect this communication link in order to exit from Scan Module tests and close the VERUS Diagnostic Tool software. A warning message displays if you attempt to shut down with the Scan Module communicating.



NOTE:

Damage to the vehicle electronic control module (ECM) may occur if communication is disrupted. Make sure the data cable and the USB cable are properly connected at all times during testing. Exit all tests before disconnecting the test cable or turning off the tool.



To exit the Scanner:

1. From an active screen, select **Exit** from the Scanner Toolbar to return to the Systems Menu.
2. From the Systems Menu, select **Back** from the Scan Module data menu.

A “stopping communications” message briefly displays followed by the main menu.

Now, the Scan Module is no longer communicating with the vehicle and it is safe to return to the Home screen and exit the VERUS Diagnostic Tool.

4.7 Downloading Firmware

The internal programming of the Scan Module, known as the firmware, can be updated using the VERUS Diagnostic Tool. Firmware updates increase the Scan Module diagnostic capabilities, typically by adding new tests, new models, or enhanced applications to the databases.

The Diagnostic Tool automatically searches for available updates for all of the VERUS components when it is connected to the internet. Any updates that are found are downloaded and stored on the device. However, the update must be installed in order to complete the process. This section describes installing an update to the Scan Module firmware. A notification message displays if an update is available when Scanner is selected from the VERUS Home screen (Figure 4-31).

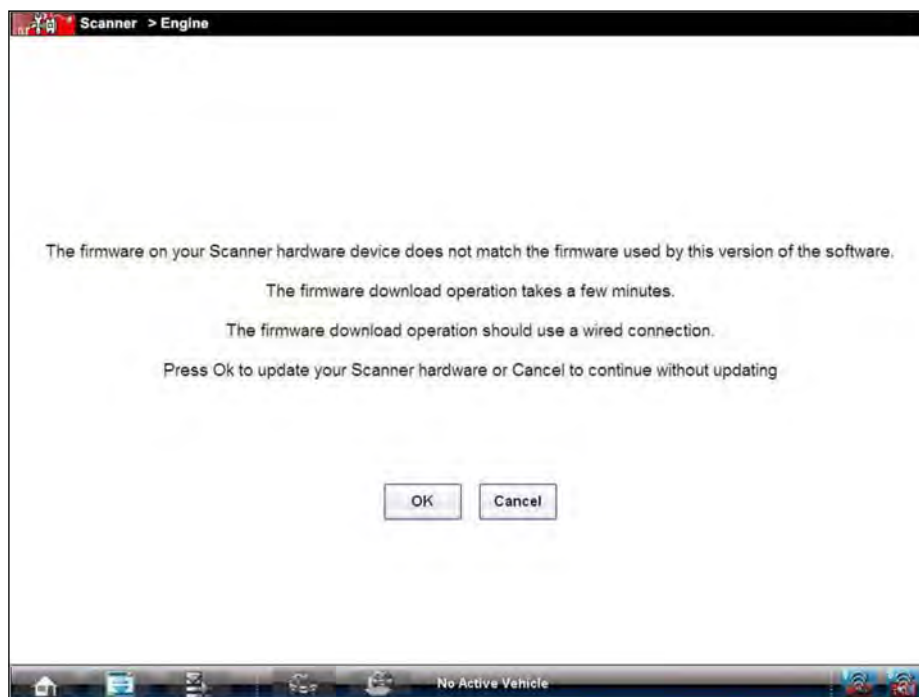
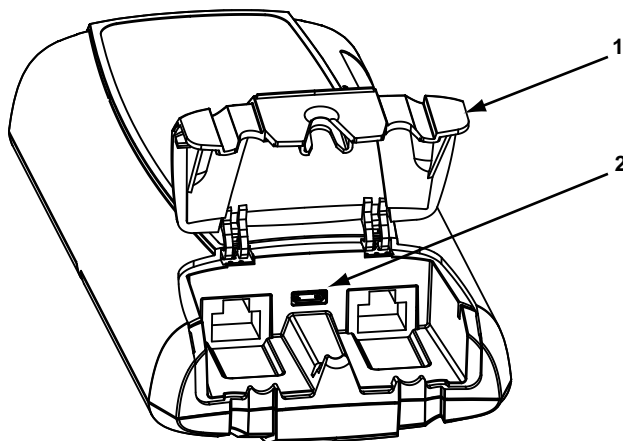

Figure 4-31 Firmware update available message

Selecting OK from the firmware update message begins the process as explained in the following procedure, selecting Cancel closes the message and starts the Scan Module. Not updating the firmware does not impact operations, the Scan Module remains fully functional but may not benefit from the additional features available in the update. Therefore, you can delay updating the firmware until it is a convenient time to have your VERUS out of service for a few minutes.

**To update the firmware:**

1. Power on the VERUS wireless Scan Module.
2. Connect a wireless Scan Module to the Diagnostic Tool as follows (Figure 4-32):
 - a. From the bottom of the Scan Module, gently lift up and out on the sides of the handgrip to free it from Scan Module housing.
 - b. Open the hinged cover on the base of the Scan Module to expose the service ports.
 - c. Plug the small end of the USB cable into the USB jack on the Scan Module.



1— Hinged cover

2— USB jack

Figure 4-32 Scan Module service jack

- d. Plug the large end of the USB cable into one of the ports on the side of the Diagnostic Tool.

**NOTE:**

A wireless Scan Module must be connected to the Diagnostic Tool with the USB cable to update the firmware. The USB cable also provides power to the Scan Module so there is no need to connect to a vehicle to turn on the Diagnostic Tool.

3. Select **Scanner** from the VERUS Home screen.

4. Select **OK** when the firmware update notification displays (Figure 4-31).
The firmware update begins and installation progress is tracked on the screen (Figure 4-33).



Figure 4-33 Sample update in progress screen

- A "successfully updated" message displays once the installation is complete (Figure 4-34).



Figure 4-34 Sample firmware update complete message

5. Select **OK** to close the message and return to Scan Module operations.
The Scan Module, with the latest firmware update, is now ready to use.

This Home screen option allows you to access Generic OBD-II Scan Module tests without completing a vehicle identification. This presents a quick way to check for diagnostic trouble codes (DTCs), isolate the cause of an illuminated malfunction indicator lamp (MIL), check monitor status prior to emissions certification testing, verify repairs, and perform a number of other services that are emissions-related. OBD Direct is also used for testing OBD-II compliant vehicles that are not included in the Scan Module databases.

OBD Direct is a Scan Module function and the Scan Module must be connected to the test vehicle and communicating with the Diagnostic Tool. Keep in mind, this function provides generic OBD-II information only. Select Scanner from the VERUS Home screen for enhanced OBD-II functions.

Options for the Menu on the Toolbar at the base of the screen are the same as those available for the Scanner module. Refer to [Menu Options on page 15](#) for details.

Selecting OBD Direct on the VERUS Home screen opens a menu with two options ([Figure 5-1](#)):

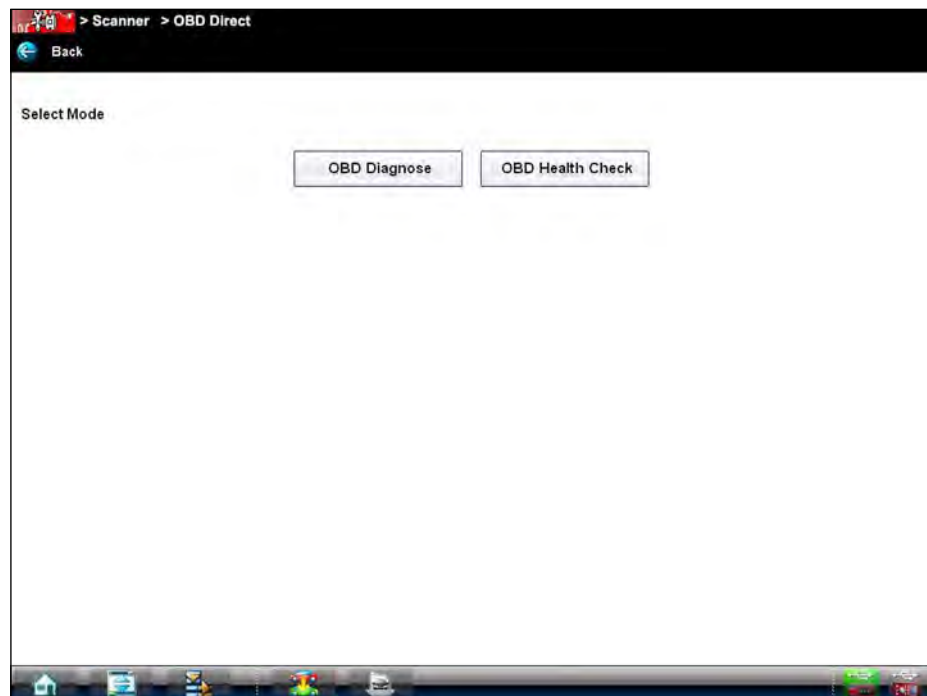

Figure 5-1 Sample OBD Direct main menu

5.1 OBDDirect Health Check

The OBDDirect Health Check offers a way to quickly check for and clear generic diagnostic trouble codes (DTCs) and to check readiness monitors. Selecting OBDDirect Health Check opens a submenu of options (Figure 5-2).

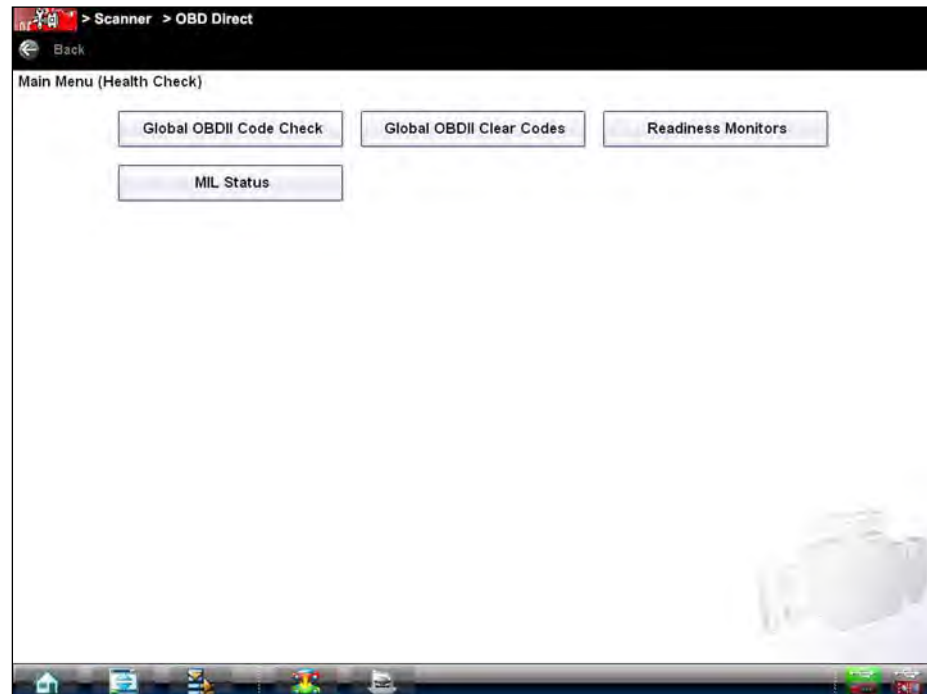

Figure 5-2 Sample OBDDirect Health Check menu

5.1.1 Global OBD II Code Check

This option displays any stored emission related generic DTCs reported by the ECM. Selecting this option opens a submenu with two choices: Codes and Pending Codes.

Select an option to display the code list. Refer to [Codes Menu on page 41](#) and the *Global OBD Vehicle Communication Software Manual* for additional information.

Codes

The Codes option displays a list of current emission related DTCs.

OBDDirect-II Codes have a priority according to their emission severity, with higher priority codes overwriting lower priority codes. The priority of the code determines the illumination of the MIL and the code erase procedure. Vehicle manufacturers have implemented the priority ranking differently, so there will be differences between makes.

Pending Codes

The purpose of this service is to enable the scan tool to obtain “pending” or maturing diagnostic trouble codes. These are codes whose setting conditions were met during the last drive cycle, but need to be met on two or more consecutive drive cycles before the DTC actually sets.

The intended use of this service is to assist the service technician after a vehicle repair and after clearing diagnostic information, by reporting test results after a single driving cycle.

- If a test failed during the driving cycle, the DTC associated with that test is reported. If the pending fault does not occur again within 40 to 80 warm-up cycles, the fault is automatically cleared from memory.
- Test results reported by this service do not necessarily indicate a faulty component or system. If test results indicate another failure after additional driving, then a DTC is set to indicate a faulty component or system, and the MIL is illuminated.

5.1.2 Global OBD II Clear Codes

This option is used to clear all emission related diagnostic data such as, DTCs, freeze frame data, and test results from the memory of the selected ECM. Although OBD Direct only displays generic OBD-II data, clearing codes erases all of the stored data including any enhanced codes.

A confirmation screen displays when the clear codes option is selected to prevent accidental loss of data. Select Yes on the confirmation screen to continue. Refer to [Codes Menu on page 41](#) and the *Global OBD Vehicle Communication Software Manual* for additional information.

5.1.3 Readiness Monitors

Use this menu option to check the readiness of the monitoring system. such as the transmission controller components and the engine components. If a monitor system is not supported, it is not displayed. Test results are shown in the data viewer ([Figure 5-3](#)).



Figure 5-3 Sample readiness monitor test report

Scroll to view the entire list of Readiness Monitors to ensure that all tests are complete. It is possible to print the readiness test status or save it as part of a Vehicle history.

5.1.4 MIL Status

This item is used to check the current condition of the Malfunction Indicator (MIL). Additional information, such as which ECM commanded the MIL on and also the distance travelled while the MIL is on (if supported), can also be displayed. It is also possible to print the MIL Status.

5.2 OBD Diagnose

Selecting OBD Diagnose opens a menu with the following options:

- Start Communication—begins the test session
- Connector Information—provides data link connector (DLC) location details for most models
- Manual Protocol Selection—allows you to select which protocol to use

5.2.1 Start Communication

Use the following procedure to conduct an OBD Direct test session:



To perform an OBD Direct Test:

1. Select **Start Communications** and a connection message displays ([Figure 5-4](#)).

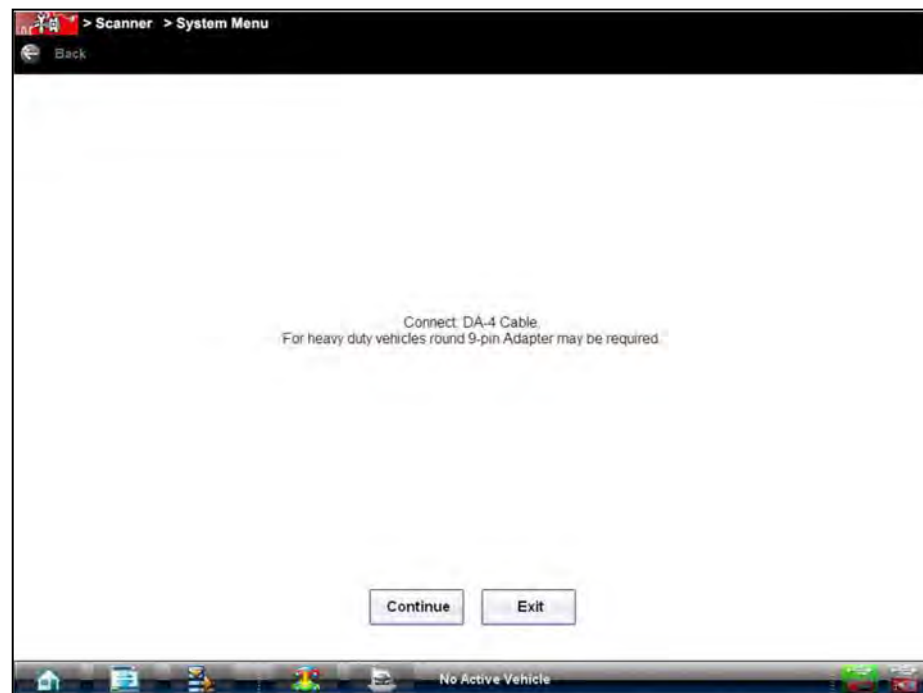

Figure 5-4 Sample generic connection message

2. Connect the Scan Module to the test vehicle as instructed using the data cable along with the specified adapter and key.
3. Select **Continue**.

A communications message that shows how many ECMs were detected, Which ECM is communicating, and which communication protocol is being used (Figure 5-5).



Figure 5-5 Sample communication message

4. Select **Continue** and a menu of available tests displays(Figure 5-6).

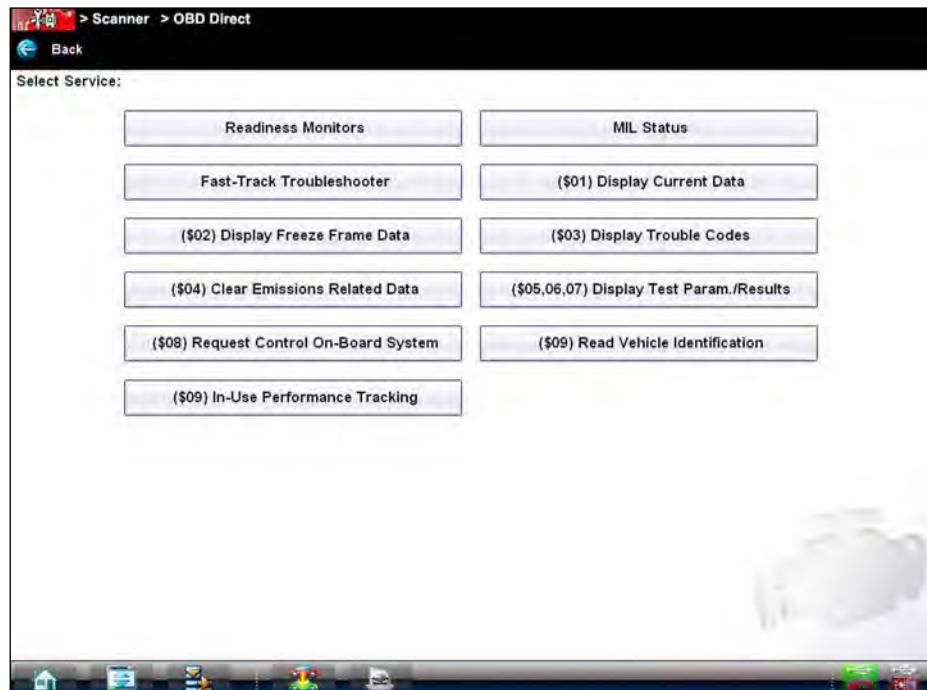

Figure 5-6 Sample Start Communication menu

5. Select a test to continue.

Readiness Monitors

Use this menu item to check the status of the monitored system. If a monitored system is not supported, it is not displayed. Scroll to view the entire list of Readiness Monitors to ensure that all tests are complete.

MIL Status

This item is used to check the current condition of the Malfunction Indicator Lamp (MIL). Additional information, such as which ECM commanded the MIL on and also the distance traveled while the MIL is on (if supported), can also be displayed. It is also possible to print the MIL Status.

(\$01) Display Current Data

Use this item to display the current emission related data from the selected electronic control module (ECM) of the vehicle. Displayed data includes analog inputs and outputs, digital inputs and outputs, and system status information broadcast on the vehicle data stream.

(\$02) Display Freeze Frame Data

This item is used to display freeze frame data for any stored emission related diagnostic trouble codes (DTC). In most cases the stored frame is the last DTC that occurred. Certain DTCs, those that have a greater impact on vehicle emission, have a higher priority. In these cases, the highest priority DTC is the one for which the freeze frame records are retained.

Freeze frame data includes a "snapshot" of critical parameter values at the time the DTC set.

(\$03) Display Trouble Codes

This is used to display any stored emission related DTCs reported by the various ECMs.

(\$04) Clear Emissions Related Data

This item is used to clear all emission related diagnostic data such as, DTCs, freeze frame data, and test results from the memory of the selected ECM.

(\$05, 06, 07) Display Test param./Results

This selection opens a submenu of test parameters and test results from various sensors, such as the oxygen sensor (O2S), monitor test results, and a record of DTCs detected during the last drive cycle. The menu includes:

- Oxygen Sensor Monitoring (\$05)
- On-Board Monitored Systems (\$06)
- DTCs Detected During Last Drive (\$07)

Request Control of On-board System (\$08)

This service enables bidirectional control of the ECM so that the Scanner is able to transmit control commands to operate the vehicle system. This function is useful in determining how well the ECM responds to a command.

Selecting opens a menu of test choices available on the identified vehicle. Options vary by make, model, and year of the test vehicle. Select a test and follow the on-screen instructions.

Read Vehicle Identification (\$09)

This selection displays the vehicle identification number (VIN), the calibration identification, and the calibration verification number (CVN) of the test vehicle.

In-use Performance Tracking (\$09)

This selection displays the "In-use Performance Tracking" of monitored data. It is basically a record of the number of times each of the monitor tests have been completed.

5.2.2 Connector Information

This option opens a database of vehicle diagnostic connector locations that includes most makes and models.



To locate a vehicle diagnostic connector:

1. Select **Connector Information** from the System menu.
2. Select a manufacturer from the list presented.
3. Select a model from the list presented.
Instructions for which, if any, cable adapter or pin to use.
4. Select **Continue**.
Information on where to locate the vehicle diagnostic connector displays.
5. Select **Continue** to return to the System menu.

5.2.3 Manual Protocol Selection

A communication protocol is a standardized way of data communication between an ECM and a scan tool. Global OBD may use several different communication protocols. The scan tool automatically connects to an available protocol, which displays on the connection message (Figure 5-5). Some vehicles communicate on more than one protocol. Use the Manual Protocol Selection option to switch to a different protocol.

Select **Manual Protocol Selection** and message displays advising you to make sure you know the correct protocol for the test vehicle. An incorrect selection may activate warning lamps and set CAN related faults on the vehicle. Select **OK** and a menu of options displays (Figure 5-7).

A communication protocol is a standardized way of data communication between an ECM and a scan tool. Global OBD may use several different communication protocols:

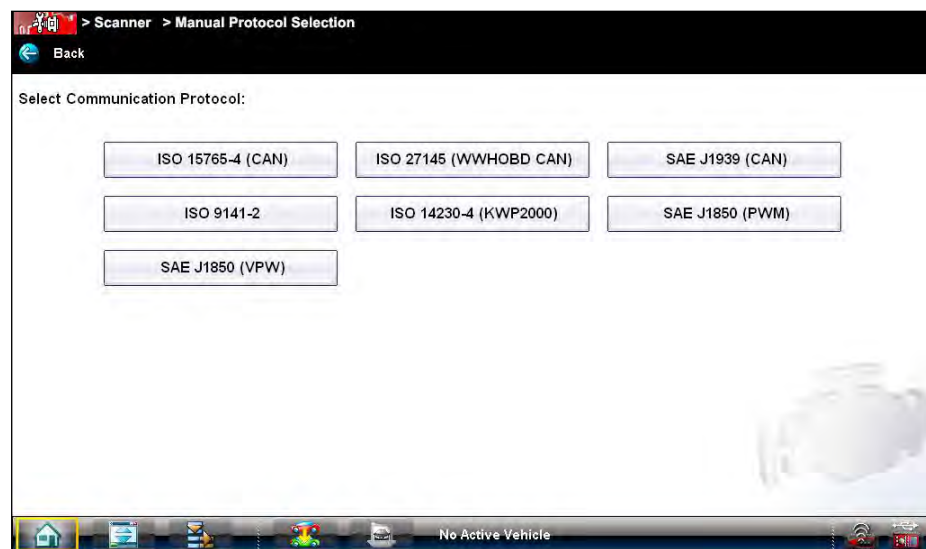

Figure 5-7 Sample communication protocol menu

When the All Protocols setting is used the Scan Module attempts to establish communication using each protocol in order to determine which one the vehicle is broadcasting on.

The Guided Component Test software is a component-testing powerhouse, providing you with a robust diagnostic database for use with scopes and meters. It is like having access to a complete library of shop manuals for testing engine-management components, transmission sensors and components, and ABS systems.

Guided Component Test helps you with everything from selecting the appropriate test for a specific component to showing the hook-up location and correct pin configuration. This software thoroughly guides and instructs you on proper testing procedures and offers tips from the internal troubleshooter database. The Guided Component Test procedures, tips, and meter settings reduce your overall set-up and diagnostic testing time. Vehicle-specific Guided Component Tests are provided for engine, transmission, ABS, charging, transfer case and suspension systems.

WARNING



Risk of electrical shock.

- **Read the *Important Safety Instructions* document provided separately for messages on the safe use of this product.**
- **This product is intended for Measurement Category I (for example, automotive 12V systems), do not use this product for Measurement Categories II, III, and IV.**
- **Measurement Category I is for performing measurements on circuits not directly connected to MAINS or MAINS circuits (an example of a MAINS circuit is 120V AC or 240V AC household or industrial electricity), do not connect this product to MAINS or MAINS circuits.**

Electrical shock can cause personal injury, equipment damage, or circuit damage.

IMPORTANT:

Maximum rated transient over voltage impulse is 500 volts, do not exceed the rated transient over voltage.

6.1 Vehicle Identification

The Guided Component Test information presented is specific to the vehicle being tested. Therefore, certain attributes of the test vehicle must be entered into the VERUS Diagnostic Tool so that the correct data can be retrieved. Vehicle identification information is carried over if you enter the Guided Component Test module either from the Scan Module or from one of the records stored in the Vehicle History module. However, you may need to enter additional attributes in some instances.

The vehicle identification sequence is menu driven, you simply follow the screen prompts and make a series of choices. Each selection you make advances you to the next screen.

6.1.1 Menu Options, Guided Component Test

Selecting the Toolbar Menu at the base of the screen offers the following options:

- [Safety Information](#)—opens the *Important Safety Instructions* document.
- [File](#)—allows you to print or save the data being viewed.
- [Top Level Menus](#)—allows you to access supplemental information and training programs.
- [Help](#)—allows you to view supporting documentation.

File

Selecting **File** opens a menu of print options:

- **Print Article**—selecting has one of two results:
 - If a printer is connected, the file is sent to the printer.
 - If a printer is not connected, the article is saved as a (.xps) file, which can be retrieved, moved, or copied and printed at a later time.
- **Print Preview**—opens a representation of what the printed file will look like.
- **Page Setup**—allows you to adjust margins and paper orientation.

Top Level Menus

Selecting Top Level Menus opens a list of the following options:

- [Power User Tests](#)
- [How To](#)
- [Features and Benefits](#)

Power User Tests

The **Power User Tests** option gives you quick access to a pre-configured meter for conducting a number of control system tests. Tests are available with or without on-screen help. Help typically provides a description of the test along with expected results and a link to the pre-set meter.

How To

How To provides a list of available on-screen instructions for performing tasks. Topics include:

- **10-MINUTE ELECTRONIC CLASS**—provides brief instruction in basic electronics and circuit connections.
- **15-MINUTE IGNITION CLASS**—provides an introduction to basic ignition testing.
- **ILLUSTRATED TERMS & DEFINITIONS**—provides definitions of terms, drawings and tips associated with Guided Component Testing.
- **NO-START BASICS**—provides a guideline for diagnosing a no-start condition.
- **O2 SENSOR & FEEDBACK SYSTEM ANALYSIS**—displays the Guided Component Test meter in the “live” graphing mode with O2S test tips to help you understand the fundamental concepts of O2S diagnostics.
- **TEST TIPS**—gives on-screen instructions for performing specific Guided Component Tests along with drawings and tips.
- **20-MINUTE CURRENT RAMP CLASSES**—provides an introduction to current ramp testing.

Features and Benefits

Selecting **Features and Benefits** opens a menu page that includes:

- **Features and Benefits**—provides descriptions and a brief overview of meter functions.
- **Accessories**—opens a menu of optional equipment available.
- **Product Description**—provides descriptions and a brief overview of meter operations.

The demonstration board not only helps you learn how to use the Guided Component Tests software, it allows you to hone your skills and diagnostic technique without an actual test vehicle.

6.1.2 Identifying a Test Vehicle

Exact procedures to identify the test vehicle may vary somewhat by vehicle and market. The following procedure, which identifies a 2008 Ford Focus for testing the fuel injection system, is typical of what to expect.



To identify a vehicle for Guided Component Test:

1. Select the **Guided Component Test** Function icon from the Home screen.
2. Select which database to load for the test vehicle if requested (optional).
After the database loads, a list of manufacturers displays.
3. Select **FORD** and a model year menu displays.
4. Select **2008** from the year menu and a list of available models displays.
5. Select **FOCUS** from the model list and a list of available engines displays.
6. Select **1.6L** from the engine list and a confirmation dialog box displays ([Figure 6-1](#)).



Figure 6-1 Sample confirmation dialog box

- From the confirmation dialog box, select **OK** to continue, or **Cancel** to return to the engine list. A list of tests available for the identified vehicle displays (Figure 6-2).

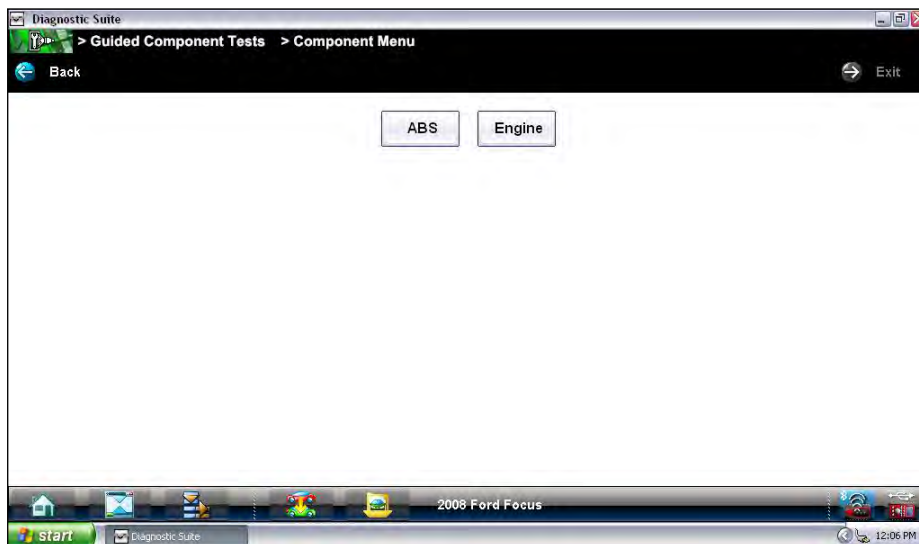

Figure 6-2 Sample available tests list

- Select **ENGINE** and a component test menu displays (Figure 6-3).

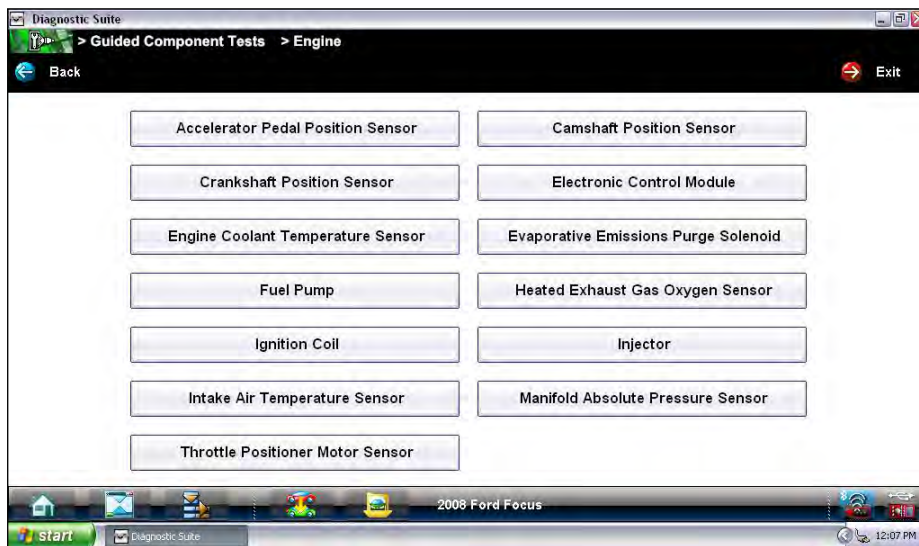

Figure 6-3 Sample available component tests list

- Select a test to continue.

The identification sequence is now complete, refer to the Operations section that follows for details on how to navigate through the Guided Component Test information and perform tests.



NOTE:

If you return to the Home screen and select Scanner or Information the vehicle identification entered here is carried over. However, additional information may be needed in some instances.

6.2 Operations

The Guided Component Test software provides vehicle specific Guided Component Test procedures and information that aid in setting up scopes and meters. Once a test vehicle is identified, you can select a Guided Component Test from the list of available tests. For most selections two main choices are available on the component menu:

1. **COMPONENT INFORMATION**—provides information on the selected component and connector pin details that assists you in understanding the components prior to diagnosis.
2. **TESTS**—provides a pre-configured list of tests, guides you through performing the tests, and offers tips and resources to reduce setup and testing time.

6.2.1 Component Information

Component Information provides details on specific vehicle components to provide a better understanding the components prior to diagnosis.

The Component Information screens contain information to assist you with testing. The screens are divided in sections to help quickly guide you to the correct information:

- **Operation**—provides a general description of normal component operation.
- **Connector**—displays the component connector and lists pin assignments.
- **Location**—identifies the component location and the best place for testing it.
- **Tech note**—provides Guided Component Test-related tips (for example, common failures or faults) as well as update or recall information.



To view component information:

1. Select a component from the tests list.
2. Select **COMPONENT INFORMATION** from the component menu.



NOTE:

An additional selection, such as front or rear for an oxygen sensor (O2S), may be required before advancing to the component information screen.

The component information screen displays (Figure 6-4).

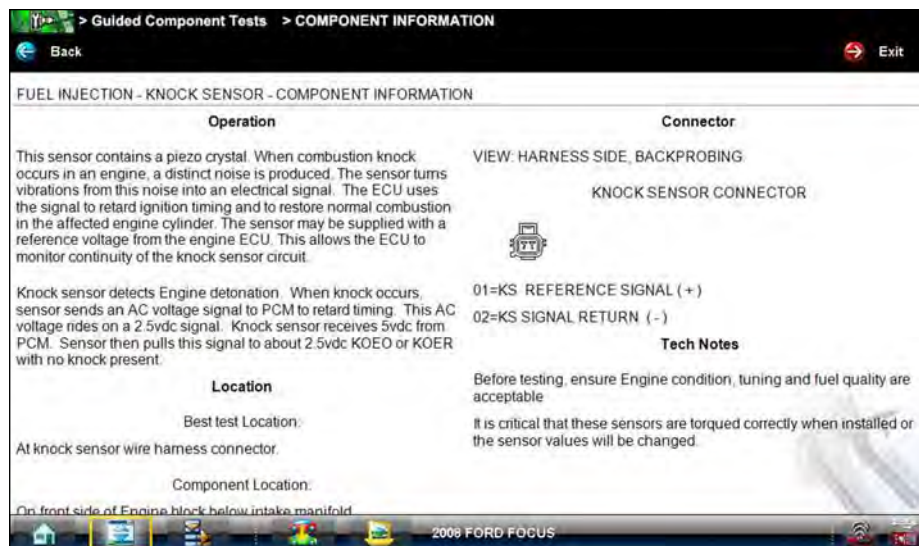

Figure 6-4 Sample Component Information screen

3. Gesture scroll to view any additional information.
4. Select **Back** at any time to return to the previous screen.

6.2.2 Tests

The Tests section guides you through the process of performing tests on a specific component. It also provides specifications, tips on how and where to connect the test meter leads, and also configures the multimeter or lab scope to perform the selected test.



To select a test:

1. Select a component from the list.
2. Select **TESTS** to open the submenu.



NOTE:

More than one selection is available in some instances. For example, a primary and a secondary tests selection display when ignition tests is selected.

The submenu shows all the tests available for the selected component, choices may include:

- DC voltage test
- Out of range signal test
- Resistance test
- Signature test
- Frequency test
- Pulse width test

Some tests open an additional submenu when more than one option is available.

3. Select a test option and the test screen displays (Figure 6-5).

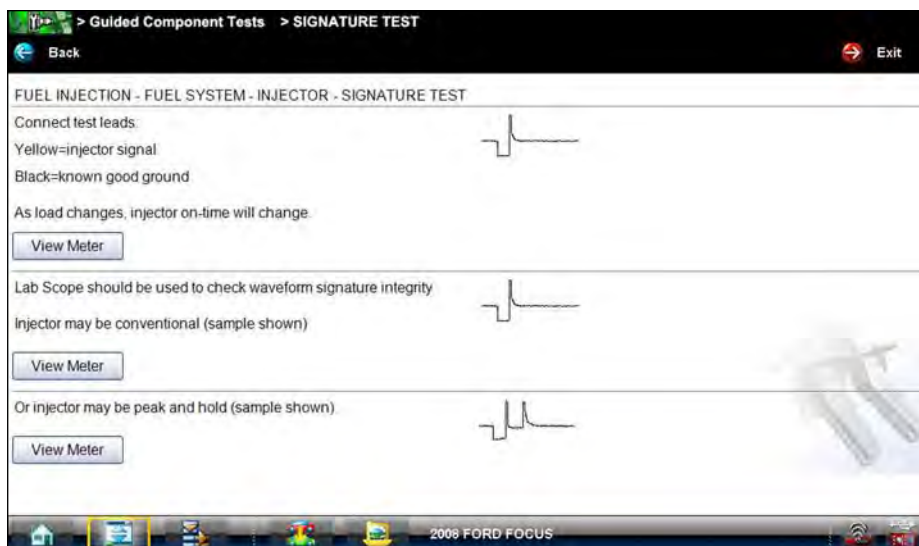

Figure 6-5 Sample Test screen

4. Gesture scroll to view any additional information.
5. Select **Back** at any time to return to the previous screen.

Hyperlinks

Guided Component test screens contain hyperlinks that either take you to another page that contains additional information or open an additional window on top of the current screen. Hyperlinks display as icons. Common hyperlinks are:

- **View Meter**—opens a live meter set up to perform the test in the lower portion of the screen (Figure 6-6). Once the meter view is open, the Guided Component Test toolbar at the top of the screen is replaced by the Scope Multimeter toolbar, which allows you to make adjustments to the settings. See “Scope Multimeter Toolbar” on page 84 for details.
- **Show More Information**—advances to a new screen with more detailed information about a particular test, select **Back** to return to the test screen.

A Meter icon, which is only available in the Guided Component Test view meter mode, appears on the upper toolbar (Figure 6-6).

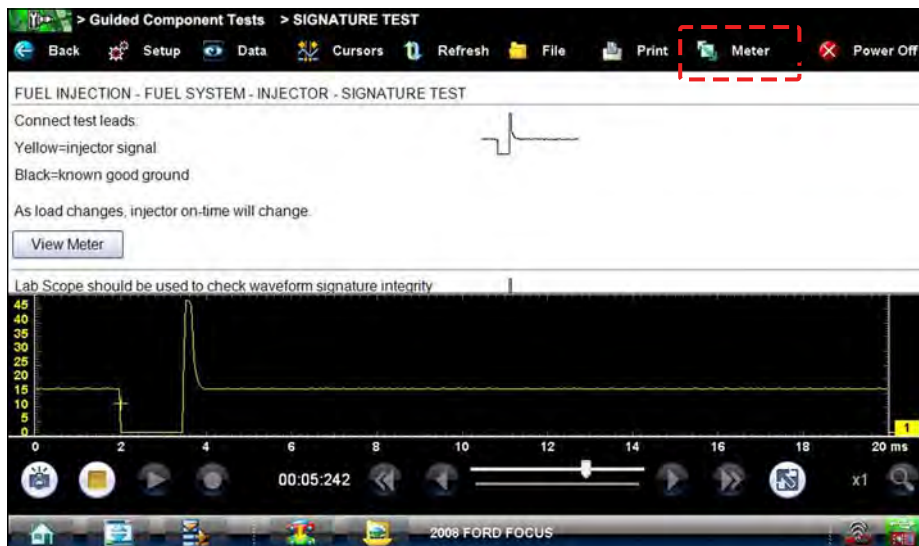

Figure 6-6 Sample view meter screen

Three view meter options are available:

1. With View Meter active (Figure 6-6), select the toolbar **Meter** icon once and the meter expands to fill the entire screen.
2. Select the **Meter** icon a second time and the meter opens as a separate window (Figure 6-7).

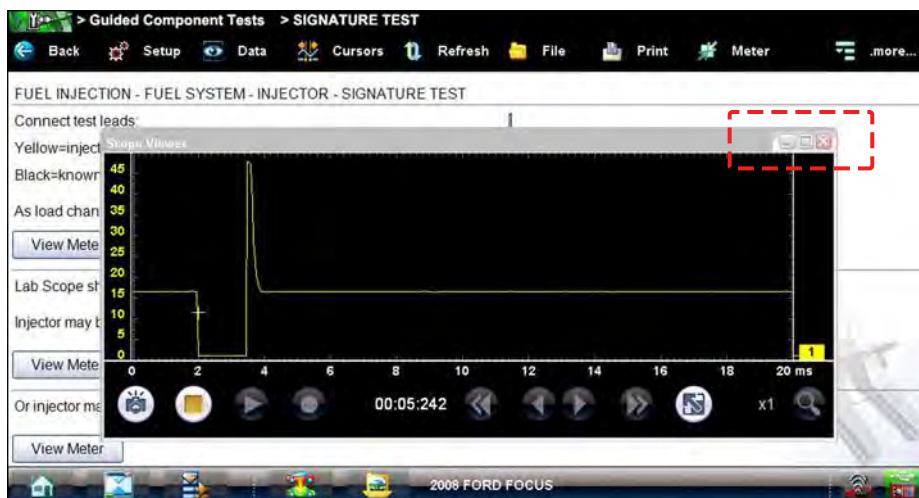

Figure 6-7 Sample meter view in a separate window

This meter window can remain open if you switch to the Scan Module and can be accessed from the Windows toolbar at the bottom of the screen. You can also resize and reposition the meter window on the screen.

Selecting the **Close** icon (red box with an X) when viewing the meter in a separate window closes the meter and return you to the Guided Component Test screen.

The meter window can remain open if you switch to the Scan Module. It is accessed from the Windows toolbar at the bottom of the screen. You can also resize and reposition the meter window on the screen.

3. Select the **Meter** icon a third time to close the window and return to the standard view as shown in [Figure 6-6](#).

Select **Exit** from the toolbar to close meter view and return to the Guided Component Test screen.

Connecting to a Test Vehicle

Before performing a test, you must connect the meter test leads to the vehicle. Certain Guided Component Tests require the use of specific leads. Information on specific leads and other connecting information displays in the initial test screen. Follow the on-screen connection instructions in the test procedure and support sections to connect the test leads.

Performing a Test

Once you connect the test leads to the vehicle, you can proceed with testing.



To perform Guided Component Tests:

1. Follow the instructions display in the test procedure section.
2. Gesture scroll to view all of the instructions, and follow the on-screen procedures.
3. Select the View Meter hyperlink to display test results.
4. Refer to the on-screen information to verify test results.

IMPORTANT:

Refer to [“Scope Multimeter” on page 76](#) for information on working with the View Meter window.

6.2.3 VERUS Toolbar Menu Options

The Menu on the VERUS Toolbar at the base of the display screen opens a list of basic operations and features. This section discusses only those menu options that are unique to the Guided Component Test module. Menu options with specific Guided Component Test functionality include:

- **File**—allows you to print or save the article viewed.
- **Help**—allows you to view supporting documentation.

Selecting a menu item opens a submenu of choices for that item, and some submenus also open an additional menu. A right arrowhead (▶) on a menu item indicates that additional choices are available for that entry. Touch an item on each menu and submenu to select it.

File

This option is used to either print or save a copy of the article currently being viewed. Highlight File and a submenu with only one option, Print Article, opens. Selecting Print Article has one of the following results:

- If VERUS is connected to a printer, the file is sent to the printer.
- If VERUS is not connected to a printer, the article is saved as a .xps file, which can be retrieved, moved, or copied and printed at a later time.

Help

Utilities and additional resources are available to you through the Help menu:

- VERUS Help—opens a version of this manual designed for on-screen viewing
- VERUS User Manual—opens a version of this manual designed printing
- Version Info—shows the version of the VERUS software on your Diagnostic Tool.

This Scope Multimeter module provides all the tools needed for performing electrical and electronic circuit tests and for monitoring signals and circuit activity. The Scope Multimeter works interactively with other modules. Selecting “View Meter” from a Guided Component Test or Scan Module test starts the Scope Multimeter module.

WARNING



Risk of electrical shock.

- **Read the Safety Information provided for important warnings on the use of this product**
- **This product is intended for Measurement Category I (for example, automotive 12V systems), do not use this product for Measurement Categories II, III, and IV.**
- **Measurement Category I is for performing measurements on circuits not directly connected to MAINS or MAINS circuits (an example of a MAINS circuit is 120V AC or 240V AC household or industrial electricity), do not connect this product to MAINS or MAINS circuits.**

Electrical shock can cause personal injury, equipment damage, or circuit damage.

IMPORTANT:

Maximum rated transient over voltage impulse is 500 volts, do not exceed the rated transient over voltage.

7.1 Getting Started

The Scope and Multimeter module enables the following VERUS functions:

- Lab Scope
- Ignition Scope
- Graphing Multimeter
- Digital Multimeter

7.1.1 Capabilities

The following tables detail the software and hardware capabilities.



NOTE:

200V to 400V scales are not to be used to measure signals greater than 50VAC (rms) or 75VDC.

IMPORTANT:

Do not use the Low Amp Probe to measure current on conductors at a potential greater than 46VAC peak or 70VDC.

Table 7-1 Scope

Function	Range	Accuracy/Comments
Signal Measurement	Ch. 1—yellow banana jack Ch. 2—green banana jack Ch. 3—blue banana jack Ch. 4—red banana jack	Each channel input is referenced to common ground input (GND—black banana jack)
Sample Rate	Single trace mode = 6 MSPS (Ch. 1 only) Dual trace mode = 3 MSPS (Ch. 1 & 2 only) Four trace mode = 1.5 MSPS (Ch. 1–4)	Continuous sampling, MSPS = mega samples per second
Bandwidth	DC–3 MHz	3 db point @ 3 MHz
Input Impedance	10 MOhm @ DC 5.8 kOhm @ 3 MHz	Channel 1–4
VDC (Full Scale)	100mV–400V	Do not measure greater than 75VDC
VAC (Full Scale)	100mV–400V	Do not measure greater than 50VAC (rms)

Table 7-2 Graphing Multimeter

Function	Range	Accuracy/Comments
Signal Measurement	Ch. 1—yellow banana jack Ch. 2—green banana jack Ch. 3—blue banana jack Ch. 4—red banana jack	Each channel input is referenced to common ground input (GND—black banana jack)
Sample Rate	1.5 MSPS	Continuous sampling, MSPS = mega samples per second
Bandwidth	DC–3 MHz	3 db point @ 3 MHz
Input Impedance	10 MOhm @ DC 5.8 kOhm @ 3 MHz	Channel 1–4
VDC (Full Scale)	75VDC	Do not measure greater than 75VDC
VAC (Full Scale)	50VAC	Do not measure greater than 50VAC (rms)
Low Amp Probe	20A scale (100mV/Amp) 40A scale (10mV/Amp)	Connect Low amp Probe (+) to Ch. 1 (yellow banana jack) and (–) to GND input (black banana jack). See NOTE below.

Table 7-3 Digital Multimeter

Function	Range	Accuracy/Comments
Signal Measurement	Ch. 1—yellow banana jack	Channel 1 input is referenced to common ground (GND—black banana jack)
VDC (Full Scale)	75VDC	Do not measure greater than 75VDC
VAC (Full Scale)	50VAC	Do not measure greater than 50VAC (rms)
Signal Measurement Input Impedance	10 MOhm	
Ohm Measurement Diode Test Continuity Test	Ch. 3—blue banana jack Ch. 4—red banana jack	Each channel input is referenced to common ground (GND—black banana jack)
Ohms	400 Ohm–4 MOhm	Fixed scales or Auto Ranging
Glitch capture	Approximately 50 uS	
Diode Test	2 V Scale	

7.1.2 Leads, Probes and Adapters

The Scope Multimeter uses standard safety banana plugs that are compatible with many accessories. The various leads, probes, clips, and adapters that are supplied with or available for the VERUS Diagnostic Tool explained in this section.

IMPORTANT:

When removing leads from their sockets, do not pull on the wire because it can damage the leads. Pull on the plug.

Channel 1 Lead

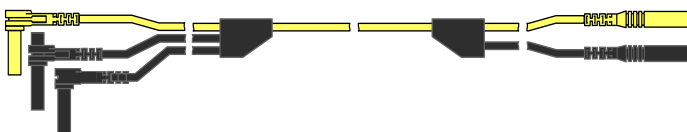

Figure 7-1 Yellow Channel 1 Lead

The shielded yellow lead is used for Channel 1 (Figure 7-1) and other channel connections that need additional grounding. The lead color matches the color of socket 1 on the VERUS display and the color of trace 1 on the test screens.

This yellow lead includes a black, right-angle, common ground plug and a black, stackable, right-angle, common ground plug. The non-stackable ground plug always connects to the ground (GND) jack on top of the Diagnostic Tool. The stackable ground plug is used for connecting additional leads, such as the Channel 2 Lead or the Secondary Coil Adapter Lead, that require grounding. The stackable lead does not need to be connected to the GND jack on the Diagnostic Tool, it grounds through the non-stackable lead.

Channel 2 Lead



Figure 7-2 Green Channel 2 lead

The shielded green lead (Figure 7-2) is used for Channel 2. The lead color matches the color of socket 2 on the VERUS display and the color of trace 2 on the test screens. This green lead includes a stackable, black, right-angle, ground plug.

Channel 3 Lead



Figure 7-3 Blue Channel 3 lead

The non-shielded blue lead (Figure 7-3) is used for either Channel 3 or Digital Meter minus (-). The lead color matches the color of socket 3 on the VERUS display, as well as the color of trace 3 on the test screen.

Channel 4 Lead



Figure 7-4 Red Channel 4 lead

The non-shielded red lead (Figure 7-4) is used for either Channel 4 or Digital Meter plus (+). The lead color matches the color of socket 4 on the VERUS display, as well as the color of trace 4 on the test screen.

Alligator Clips

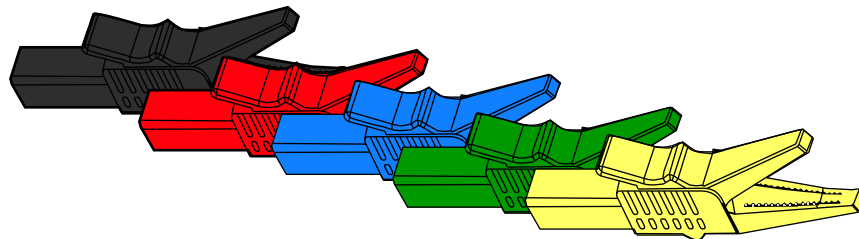

Figure 7-5 Alligator clip

Four insulated alligator clips are included and colored to match each test lead, a black clip for the common ground lead is also supplied (Figure 7-5). Each clip plugs into the straight end of a channel lead.

Test Probes

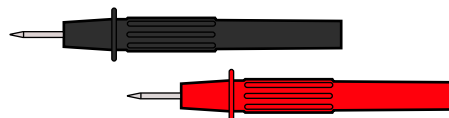

Figure 7-6 Test probe

Two test probes are included, one black and one red (Figure 7-6) and plug into the straight end of the test leads.

Secondary Coil Adapter Lead (optional)

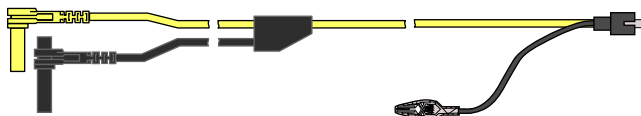

Figure 7-7 Secondary Coil Adapter lead

The optional Secondary Coil Adapter lead (Figure 7-7) connects to the clip-on secondary wire adapter, coil-in-cap adapter or coil-on-plug adapter to display secondary waveforms.

Secondary Ignition Clip-on Wire Adapter (optional)



Figure 7-8 Secondary Ignition Clip-on Wire Adapter

The optional Secondary Ignition Clip-on Wire Adapter (Figure 7-8) connects the Secondary Coil Adapter lead to the vehicle Secondary wire to display ignition patterns.

Inductive RPM Pickup Adapter (optional)



Figure 7-9 Inductive RPM Pickup adapter

The optional Inductive RPM Pickup adapter (Figure 7-9) connects to the scope auxiliary jack of the VERUS Diagnostic Tool with a DB9F plug. It can be used to trigger a waveform or display RPM. With the Ignition Scope, the RPM Pickup connects to cylinder number one to establish the firing order.

Low Amp Current Probe (optional)

The optional Low Amp Current Probe provides accurate and reliable non-intrusive testing of ignition coils, fuel injectors, fuel pumps, relays, electric motors, and parasitic draw. Use to measure current from 10 mA to 60 Amps with a resolution of 1 mA.



Figure 7-10 Low Amp Current Probe

7.1.3 Menu Options, Scope Multimeter

The Menu on the Toolbar at the base of the screen opens a menu with the following options:

- [Safety Information](#)—opens the *Important Safety Instructions* document.
- [File](#)—allows you to print or save the data or meter setup being viewed.
- [Setup](#)—allows you to adjust certain tool settings once a test has been selected.
- [Help](#)—allows you to view supporting documentation.

File

Use to print or save a copy of the data currently being viewed. Selecting opens a submenu:

- **Save Multimeter**—opens an additional submenu with these options:
 - **Save Configuration**—saves the current screen setup as a preset for quick access.
 - **Save Single Frame**—saves a recording of the current screen.
 - **Save All Frames**—saves a recording of the current screen plus all the data in the buffer.
- **Print**—opens a standard Windows Print dialog box for printing the current screen. A message will display asking if you wish to print only the scope or the entire screen. Answering No will print the entire displayed screen.

Setup

This option allows you to adjust tool settings to your personal preferences. Selecting opens a menu of the following:

- [Unit Setup](#)—opens the Unit Setup dialog box to adjust trace and display settings
- [Snapshot](#)—opens the Snapshot dialog box for selecting how triggered data is saved.
- [Ignition](#)—opens the Ignition dialog box for setting up to display secondary ignition patterns.

Help

A variety of utilities and additional resources are available through the Help menu:

- User Manual
- Version Info
- Activation Status
- Scope About

The User Manual, Version Info, and Activation Status options are the same as explained previously, see [“Menu Options” on page 15](#) for details.

Scope About

This option opens a dialog box that contains the software version and other specific details about the Scope module. A **Copy to Clipboard** icon allows you to copy and paste the information to a document or e-mail.

7.2 Navigation

The following section describes how to navigate the screen interface.

7.2.1 Screen Layout

The screens typically include the following sections ([Figure 7-11](#)):

- **Scope Multimeter Toolbar**—allows you to configure the tool for the type of test and to adjust the settings for each channel, or trace.
- **Main Body** —displays test results. Options on the toolbar let you select how tests display on the screen.
- **Trace Details**—displays trace settings, which can be adjusted or switched through the touch screen
- **Record/Playback Control Toolbar**—allows you to record and navigate through paused data.









- 1— Scope Multimeter toolbar
- 2— Main body
- 3— Trace Details
- 4— Record/Playback Control toolbar

Figure 7-11 Scope Multimeter screen layout

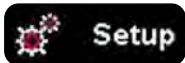
Scope Multimeter Toolbar

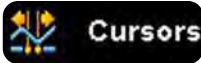
The Scope Multimeter toolbar is used to set up the tool for testing and to configure the settings for each trace. The table below gives brief descriptions of the control icons on the toolbar:

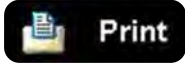
Table 7-4 Scope Multimeter toolbar icons

Name	Icon	Description
Back		Returns to the previously viewed screen.
Setup		Opens a dialog box that allows you to select personal preferences for viewing and saving data.
Data		Switches the trace information displayed at the base of the screen between three available states.
Cursors		Opens a dialog box that allows you to switch cursors on and off, and to reposition them on the screen.
Refresh		Updates data on the viewing screen.
File		Opens a dialog box that allows you to select options for saving data.
Print		Opens a dialog box that allows you to configure and print data.
Power Off		Switches the Scope Multimeter off. This retains the settings and reduces battery drain when switching to a different module. The Play and Record icons on the Playback toolbar switch the meter back on

Main Body of the Screen

The main body of the screen varies depending on what display options have been selected. Up to four traces, along with digital readouts of current signal values, signal status and triggering conditions, can be displayed simultaneously on the main body of the screen. Adjustments to the display are made through the scope toolbar as explained above.

Each trace is displayed as voltage over time on a standard oscilloscope screen. Voltage level is recorded on the vertical, or “y”, axis and time is presented on the horizontal, or “x”, axis of the screen. Values are shown for each graduation on the scales.

When using the pressure transducers, the pressure being sensed is converted into a voltage signal. However, the values are shown as pressure on the display screen rather than voltage.

Trace Details

The Trace Details section displayed at the base of the screen can be used to quickly adjust settings for capturing the trace. The Trace details are accessed using either the **Data** icon on the upper toolbar or the **Touch and Grow** icon (fingerprint) icon on the Playback toolbar. Both icons function the same and cycle the Trace Details selection through three states:

- **Displayed**—trace settings are displayed in this mode
- **Expanded**—trace settings are displayed in a larger format in this mode
- **Off**—trace settings are not displayed in this mode

Adjustments are made by selecting the item to be changed on the touch screen. A dash (–) indicates a function that is not selected, and an icon displays to indicate an active function (Figure 7-12).

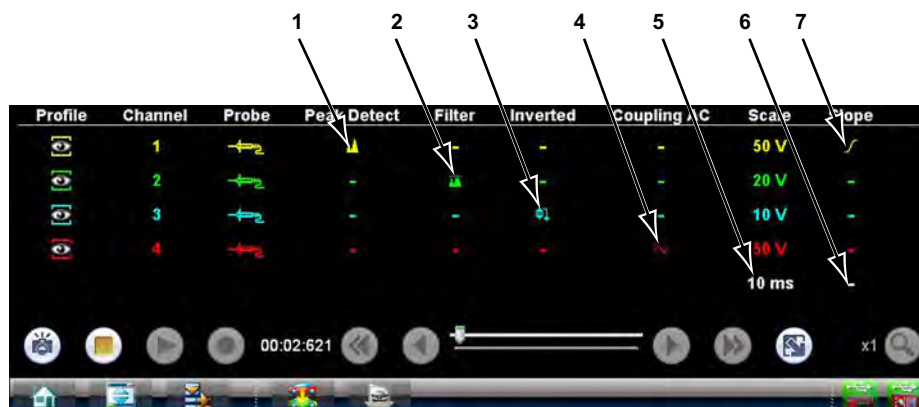

- 1— Peak Detect on
- 2— Filter on
- 3— Inverted trace
- 4— Coupling AC on
- 5— Sweep setting
- 6— Trigger setup
- 7— Trigger set on the rising slope

Figure 7-12 Sample data detail display

The following trace adjustments and settings are available:

- **Profile**—switches the trace for the selected channel on and off.
- **Channel**—opens a dialog box that allows you to configure the trace setup (see “Trace Controls” on page 90 for details).
- **Probe**—opens a dialog box that allows you to select the type of test probe being used.
- **Peak Detect**—maximizes the signal sampling rate in order to capture fast events, such as spikes, glitches and other anomalies, that may normally be undetected.
- **Filter**—smooths out the trace when the signal is disrupted by noise or other interference.
- **Inverted**—switches the polarity of the displayed signal.
- **Coupling AC**—subtracts the average value of the waveform by blocking the DC portion of an input signal in order to amplify the AC portion. This allows small variations in the trace to become visible.
- **Scale**—opens a dialog box that allows you to select the scale, which is the total value displayed on the vertical axis of the display. The value shown in white at the bottom of the list is the current sweep setting, selecting it open a dialog box that allows you to adjust the sweep (see “Sweep Controls” on page 92 for details).
- **Slope**—only active when a trigger is set, indicates whether the trigger is set to activate on the rising or falling slope of the trace. Selecting the slope icon switches the slope. The white dash at the bottom of the slope column is used to set the trigger, selecting it opens the trigger setup dialog box (see “Trigger Controls” on page 92 for details).

Record/Playback Control Toolbar

The record/playback control toolbar at the base of the screen is used for recording data and for reviewing paused data files. Use the touch screen select the icons. A position counter in the toolbar displays a numerical value of where the current screen is in relation to the entire recorded file.

Use the slider in the middle of the toolbar to quickly move through paused data.



Figure 7-13 Sample data buffer slider

Use the toolbar icons (Table 7-5) to more precisely navigate the data.

Table 7-5 Data buffer toolbar icons (part 1 of 2)











Name	Icon	Description
Snapshot		Arms the software to take a snapshot of the sampled data
Step Back		Moves to the previous point in the recorded data
Back 1Frame		Moves to the previous frame in the recorded buffer
Stop		Stops recording data
Record		Begins recording data
Play Recording		Plays the data recording in a continuous loop at actual speed
Forward 1 Frame		Moves to the next frame in the recorded buffer
Step Forward		Moves to the next point in the recorded buffer
Position Indicator		In record mode, indicates how much data is collected. In playback mode; shows the position of the buffered data currently displayed as minutes:seconds:milliseconds of elapsed time

Table 7-5 Data buffer toolbar icons (part 2 of 2)

Name	Icon	Description
Touch and Grow		Expands and collapses the Trace Detail area on the display screen to allow for easier touch control
Zoom		Increase or decrease the magnification of the graph

7.2.2 Making Selections

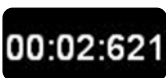
Most selections for setting up and operating the scope are made using the stylus and the scope toolbar. The cursor lines, the trace zero line, and the trigger point indicator (+) can be repositioned by selecting and dragging them in the main body of the screen.

There are two basic types of controls on the toolbar:

- Switches
- Dialog boxes

A Switch changes states when selected. Changes happen immediately as the selection is made.

A dialog box opens as a separate window on the screen and typically includes a number of choices. Changes happen immediately, however, the dialog box must be closed to return to the main window and continue. Make a selection to close the dialog box.

7.3 Operations

This section describes configuring the scope or meter and performing tests. Selecting “View Meter” from a Guided Component Test or Scan Module automatically configures the scope or meter.

7.3.1 Starting the Scope and Multimeter

Use the following procedure to set up the scope multimeter for performing tests.



To start the scope multimeter:

1. Select the **Scope Multimeter** icon on the VERUS Home screen.
The Scope Multimeter main menu, a list of setup options, displays;
 - Lab Scope
 - Ignition Scope
 - Graphing Meter
 - Digital Multimeter
 - Presets
2. Select the correct main menu option for the tests to be performed.
A submenu of scope or meter configuration displays, see below for additional information.
3. Select to select the correct configuration for the tests to be performed.
The Scope Multimeter displays configured for the selected test.

Lab Scope Options

The following options are available for testing:

- 4 Channel Lab Scope
- Volts DC
- Low Amps (20)
- Low Amps (40)
- Low Amps (60)
- Ignition Probe
- 100 PSI Vacuum
- 100 PSI Pressure
- 500 PSI Pressure
- 5000 PSI Pressure

Graphing Options

The following options are available for testing:

- 4 Channel Graphing
- Volts DC
- Volts DC Average
- Volts AC RMS
- Frequency
- Pulse Width

- Injector Pulse Width
- Duty Cycle
- Low Amps (20)
- Low Amps (40)
- Low Amps (60)
- MC Dwell (60)
- MC Dwell (90)
- 100 PSI Vacuum
- 100 PSI Pressure
- 500 PSI Pressure
- 5000 PSI Pressure

Ignition Scope Options

The following options are available for testing:

- Parade
- Cylinder
- Raster
- Superimposed
- Single Cylinder Ignition

Digital Multimeter Options

The following options are available for testing:

- Volts DC
- Volts DC Average
- Volts AC RMS
- Ohms
- Diode/Continuity
- Low Amps (20)
- Low Amps (40)
- Low Amps (60)

Presets

Presets are factory configured meter settings for common Guided Component Tests. Selecting opens a list of available setups. Selecting from the list opens the scope multimeter configured to perform the selected test. In addition to the factory presets, you can create your own custom meter configurations and save them as presets.

7.3.2 Measurement Out of Range

A group of arrows display when a measurement is out of range for the scale selected:

- Arrows pointing UP—measurement over maximum range
- Arrows pointing DOWN—measurement under minimum range

Voltage measurements also display arrows in place of live values when the voltage exceeds the input rating of the meter.

WARNING



Risk of electrical shock.

- **Do not exceed voltage limits between inputs as indicated on the rating label.**
- **Use extreme caution when working with circuits that have greater than 40 volts AC or 24 volts DC.**

Electrical shock can cause personal injury, equipment damage, or circuit damage.

IMPORTANT:

If arrows are displayed in the live voltage values, discontinue circuit testing.

Correct an out-of-range condition by selecting a scale setting appropriate for the signal being sampled. See [“Trace Controls” on page 90](#) for more information.

7.3.3 Scope and Multimeter Setup

The following sections explain how to adjust the scope and multimeter for the specific type of signal being sampled. Most of these setup operations are available from the toolbar.

Trace Controls

Trace controls are used to adjust individual characteristics of how the signal is sampled and displayed for each of the four traces.



To adjust trace controls:

1. Select **Setup** from the Scope Multimeter toolbar.
The Scope Multimeter Preferences dialog box opens.
2. Select **Traces** to open the submenu.
3. Select the tab for the trace to be configured from the submenu.
The traces dialog box displays ([Figure 7-14](#)).

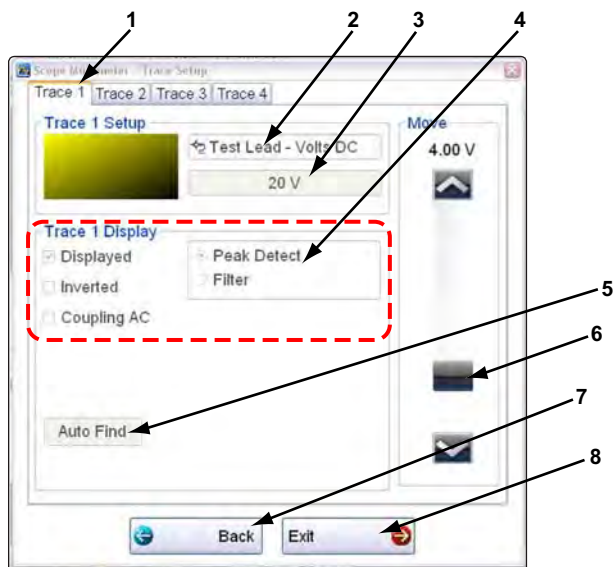

- 1— Trace tabs
- 2— Trace Probe icon
- 3— Trace Scale icon
- 4— Trace characteristics check boxes
- 5— Baseline position
- 6— Auto Find icon
- 7— Back icon
- 8— Exit icon

Figure 7-14 Traces dialog box

4. Select the **Trace Probe** icon to open the menu.
5. Highlight a probe on the list and select **OK** to close the window.
6. Select the **Trace Scale** icon to adjust the vertical scale, of the display. A dropdown menu opens, menu options vary depending upon which test lead is selected.
7. Select a trace scale option, then close the window.
8. Select or deselect the trace characteristic items as needed:
 - **Displayed**—this trace is on screen when checked, and not visible when not checked.
 - **Inverted**—signal polarity is reversed when checked, normal when not checked.
 - **Coupling AC**—check when sampling an AC signal, uncheck for DC signals.
 - **Peak Detect**—use when trying to capture a fast event or signal glitch.
 - **Filter**—use when radio frequency interference (RFI) may be disrupting the signal.
9. The scope samples the signal and internally calculates the best way to display it when **Auto Find** is selected. A scale and the vertical position for the zero line of the trace that allows the whole waveform to fit on the screen is established when Auto Find is selected. If Auto Find is selected on the trigger channel, it also sets the trigger level halfway between the minimum and maximum value of the sampled signal to provide a stable waveform.
10. The baseline position is the zero line of the trace, use the slider and arrows to adjust it.
11. Select **Back** to return to the Preferences dialog box, or select **Exit** to return to the scope.

Sweep Controls

Sweep is the amount of time represented by the screen, or the horizontal scale of the display.



To adjust Sweep controls:

1. Select **Setup** from the Scope Multimeter toolbar.
The Scope Multimeter Preferences dialog box opens.
2. Select **Sweep** icon to open the sweep dialog box (Figure 7-15)

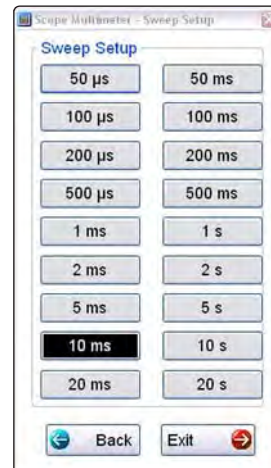

Figure 7-15 Sample Sweep Setup dialog box

3. Choose an option from the list.
4. Select **Back** to return to the Preferences dialog box, or select **Exit** to close the dialog box and return to the scope.

Trigger Controls

Triggering allows you to set the scope so that it only begins sampling and displaying a trace once predetermined signal conditions, or triggers, are met. The trigger point is indicated by a plus sign (+) on the scope grid. The plus sign can be dragged across the grid with the stylus to roughly position it. The trigger controls allow you to precisely position the trigger.



To adjust trigger controls:

1. Select **Setup** from the Scope toolbar. The Scope Multimeter Preferences dialog box opens.
2. Select **Trigger** to open the Trigger Setup dialog box (Figure 7-16).
3. Use the dialog box controls to establish the position for triggering.
4. Select **OK** to close the dialog box.
5. Select **Back** twice to close the Scope Multimeter Preferences dialog box.

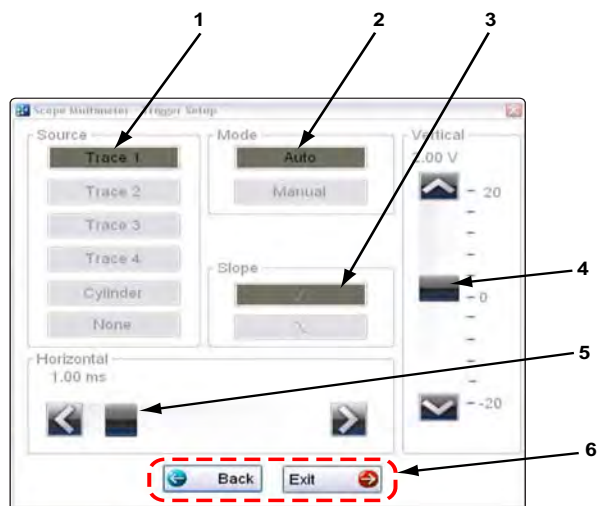

- 1— Source**—selects the triggering event:
- Trace 1—sets the trigger to channel 1.
 - Trace 2—sets the trigger to channel 2.
 - Trace 3—sets the trigger to channel 3.
 - Trace 4—sets the trigger to channel 4.
 - Cylinder—sets triggering to the firing of a cylinder detected by the optional RPM Pickup or Secondary Ignition Adapter.
- 2— Mode**—sets the method of triggering:
- Auto (automatic)—if a trigger is found, the waveform displays. If a trigger is not found after about a half second, the waveform and a “trigger not found” message displays.
 - Manual—if a trigger is found, the waveform displays. If a trigger is not found nothing displays (no waveform and no message).
- 3— Slope**—sets triggering to the rising (top icon) or falling (lower icon) slope of the signal waveform.
- 4— Vertical position**—moves the trigger position up and down on the grid.
- 5— Horizontal position**—moves the trigger timing left and right on the grid
- 6—** Select **Back** to return to the Preferences dialog box, or select **Exit** to close the dialog box and return to the scope.

Figure 7-16 Trigger controls

View Controls

Use the view controls to set display attributes.



To adjust view controls:

1. Select **Setup** from the Scope Multimeter toolbar.
The Scope Multimeter Preferences dialog box opens.
2. Select **View** to open a submenu.
3. Select an option from the submenu dialog box. Option details are explained below.

Four options are available on the submenu:

- **Display**—use to adjust what information displays and how it appears
- **Layout**—use to set how many traces display and how they display on the screen
- **Units**—use to adjust time and voltage interval settings
- **Back**— use to return to the Preferences dialog box, or select **Exit** to close the dialog box and return to the scope.

Display Settings

Selecting **Display** from the View submenu opens the Display dialog box (Figure 7-17).

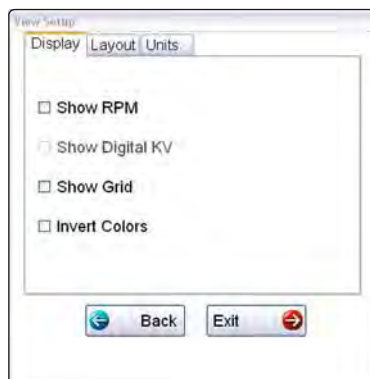

Figure 7-17 Sample Display dialog box

The following options are available from the Display dialog box:

- **Show RPM**—adds an engine speed field at the top of the screen (Figure 7-18).

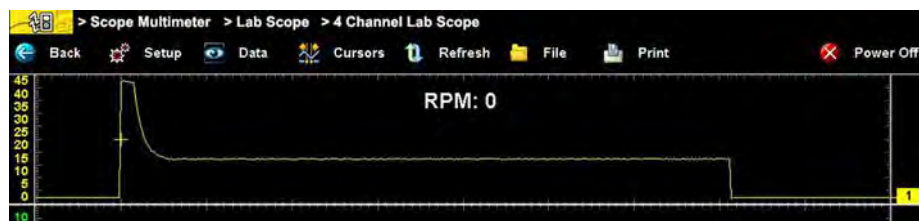

Figure 7-18 Sample Show RPM selected

- **Show Digital KV**—available only in ignition scope, adds a kilovolt reading to the screen.
- **Show Grid**—switches grid lines on the screen off and on (Figure 7-19).



Figure 7-19 Sample grid selected

- **Invert Colors**—switches the screen background to white, this saves ink when printing.

Layout Settings

The selected radio knob on the Layout dialog box shows which setting is active. Use a finger or the stylus to switch between settings:

- **1 window**—shows all traces on the same screen (Figure 7-19).
- **2 windows**—shows two separate traces in two ways: horizontal, one below another (Figure 7-20) or vertical, side-by-side (Figure 7-21)

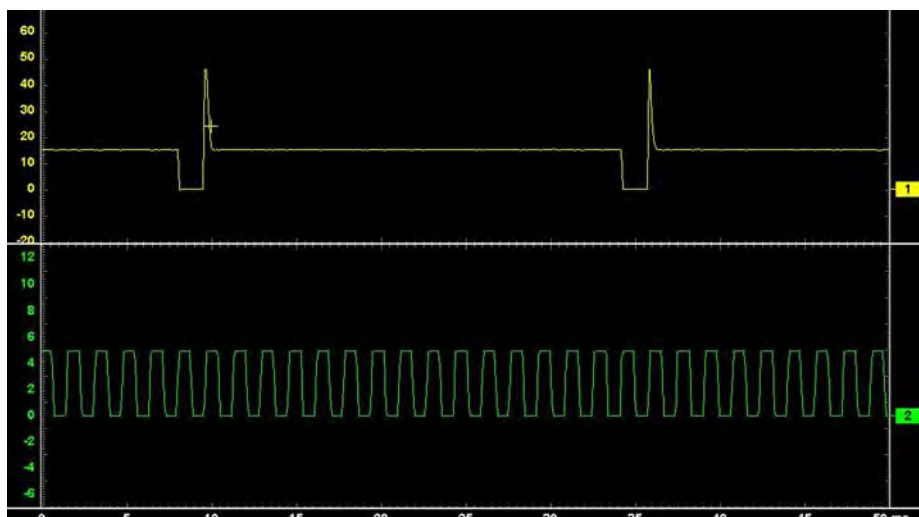

Figure 7-20 Sample 2 Windows horizontal display

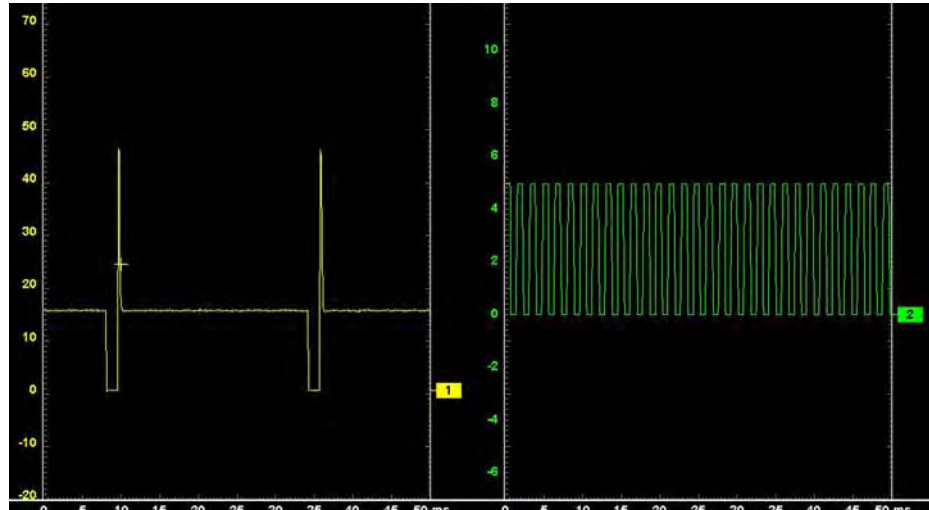

Figure 7-21 Sample 2 Windows vertical display

- **3 windows**—shows three traces, one below another, on the same screen (Figure 7-22).

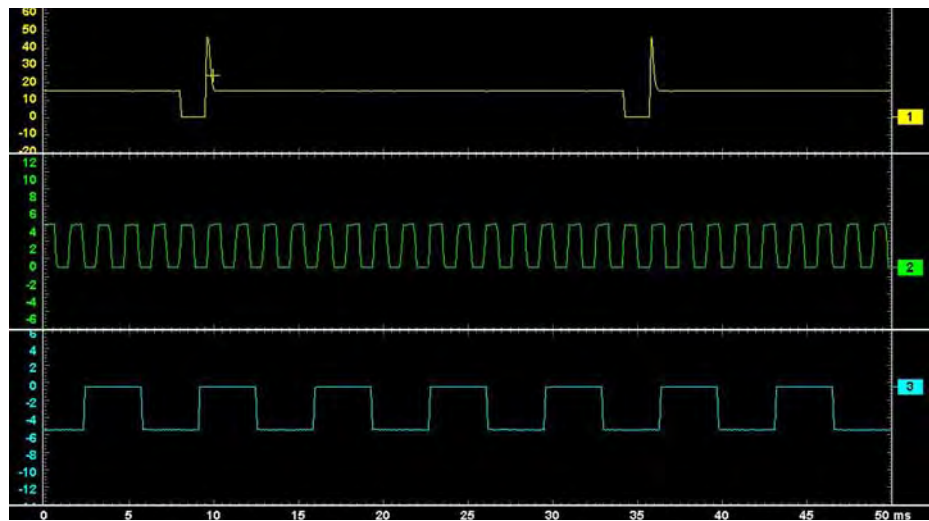

Figure 7-22 Sample 3 Windows display

- **4 windows**—shows four traces, one below another, on the same screen.

Units Settings

The Units dialog box allows you to switch between Full Scale or Per Division settings for the trace setup and the display settings. Selecting Full Scale configures the units to the full viewing area of the screen, while Per Division adjusts the units to a single division (one tenth) of the screen.

The selected radio knob on the Units dialog box shows which setting is active. Use a finger or the stylus to switch between settings (Figure 7-23).



Figure 7-23 Sample View Units dialog box

Setup Controls

Basic tool settings are adjusted here.



To adjust setup controls:

1. Select **Setup** from the Scope Multimeter toolbar.
The Scope Multimeter Preferences dialog box opens
2. Select **Setup** from the dialog box.
A submenu of options displays:
 - **Units**—use to set how measurement values display, US standard or metric
 - **Snapshot**—use to adjust the percentage of data captured following a trigger event
 - **Ignition**—use to configure the optional ignition scope for the test vehicleSelecting from the submenu opens a dialog box for that item. Dialog box options for each item are discussed in the following sections.
3. Make dialog box selections as needed.
4. Select **Back** to return to the Preferences dialog box, or select **Exit** to close the dialog box and return to the scope.

Unit Setup

The units of measurement can be changed between US standard or metric units of measure for pressure and vacuum readings. The table below shows available unit values.

Abbreviation	Description
bar	bar
inHg	inches of mercury
kg/cm2	kilograms per centimeter squared
kPa	kilopascal
mmHg	millimeters of mercury
psi	pounds per square inch

Selecting Units opens the Setup dialog box. The selected radio knobs on the Setup dialog box show which settings are active (Figure 7-24).

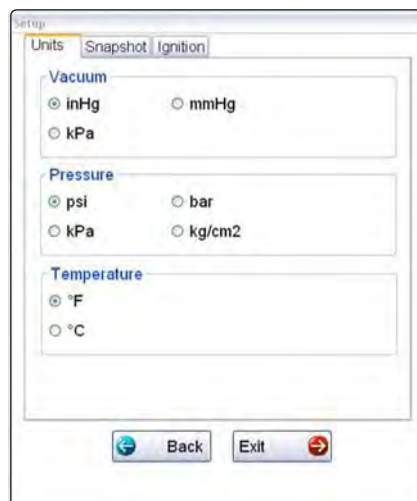

Figure 7-24 Sample Setup Units dialog box

Snapshot

The Snapshot tab of the Setup dialog box opens a window that allows you to select how much data is captured after a triggering event (Figure 7-25). Available selections, which range from ten to ninety percent in ten-percent increments, are shown as icons with the current setting highlighted. Select a icon, then select **OK** to close the dialog box.

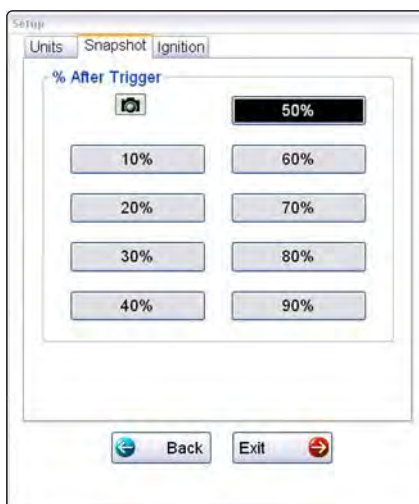

Figure 7-25 Sample Snapshot dialog box

Refer to [“Trigger Controls” on page 92](#) for information on how to setup a trigger.

Ignition

The Ignition tab of the Setup dialog box is used to configure the scope for displaying secondary ignition patterns. There are two main selection fields (Type and Cylinders) and two fields that vary depending upon the type of ignition system selected in dialog box (Figure 7-26).



Figure 7-26 Sample Setup Ignition dialog box



To setup Ignition tests

1. Select the **Setup** icon to open the Setup dialog box.
2. Select the **Ignition** tab of the dialog box.
3. Highlight the ignition system for the test vehicle in the “Type” field:
 - **Standard**—use for systems with a distributor
 - **Waste Spark**—use for coil pack systems that fire 2 plugs simultaneously
 - **Direct**—use for coil-on-plug systems
 - **Other**—use for systems that do not fit any of the above categories
4. Select the number of cylinders for the test vehicle in the “Cylinders” field.
Scroll through the list using the up and down arrows on either side of the number.
5. This step varies depending upon the type of ignition system:
 - If testing a Standard, Waste Spark or Direct system, select the Firing Order.
 - If testing an Other system, select the RPM Factor.
Scroll through the list of available choices using the up and down arrows below the displayed firing order or RPM factor.
6. This step also varies depending upon the type of ignition system:
 - If testing a Standard or Direct system, choose between Coil and Plug for the Number 1 Trigger.
 - If testing a waste Spark system, select the polarity of the firings using the +, –, and arrow icons.
7. Select **Back** to return to the Preferences dialog box, or select **Exit** to close the dialog box and return to the scope.

Data

The **Data** icon on the toolbar switches the trace details information at the base of the screen as previously in [“Trace Details” on page 84](#).

Cursor Controls

The cursor controls include a Show Cursors check box plus a slide control and arrows for moving the cursor position left or right. Select **Cursors** from the toolbar to open the Cursors dialog box (Figure 7-27).

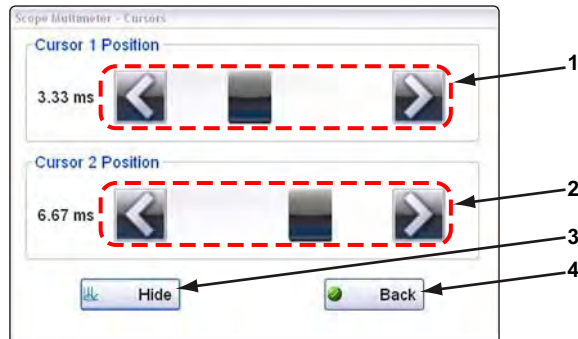

- 1— Cursor 1 controls
- 2— Cursor 2 controls
- 3— Show or Hide icon
- 4— Back icon

Figure 7-27 Cursor controls

Cursor 1, the top slider and arrows, is the left-hand cursor on the screen. Cursor 2, the lower set of controls, is the right-hand cursor on the screen. Drag the slider or select the arrows to position the cursors. Each tap of the stylus moves the cursor incrementally in the direction of the arrow.

Select **Show** to display the cursors (the icon changes to Hide).

Select **Hide** to conceal the cursors (the icon changes to Show).

Select **Back** to close the dialog box.

Refresh Controls

Selecting the **Refresh** icon from the Scope Multimeter Toolbar clears the minimum and maximum digital values and updates the viewing screen.

File Controls

Selecting File from the toolbar opens a dialog box with a menu of save options:



Figure 7-28 Sample file setup dialog box

- **Save Configuration**—saves the current setup values as a preset.
- **Save Single Frame**—saves the data currently on the screen only.
- **Save All Frames**—saves the current screen plus all the data stored in the buffer.



To save a file or configuration:

1. Select **File** from the toolbar.
2. Select a save option from the dialog box.
The Save As dialog box and the virtual keyboard open.
3. Use the keyboard to name the file to be saved, then either select the **Save** icon or select **return** on the keyboard.



Figure 7-29

A configuration description dialog box opens.



NOTE:

The description entered here is what displays in the information panel of the Data Manager.

4. Use the keyboard to enter a description of the file to be saved.
5. Select the **OK** icon or select **return** on the keyboard.
6. Select **OK** to close the file setup dialog box.

Once a configuration is saved, it becomes available as a preset. Files are saved to the Scope Multimeter Data Folder and can be retrieved through the **Data Manager**.

Print Controls

Selecting Print from the toolbar opens a standard Windows Print dialog box set up to print the current screen. A printer must be connected and setup on the VERUS Diagnostic Tool. If not, the “Add Printer Wizard” opens and guides you through the procedure. Select from the menus as needed.

After using the Scan Module, Guided Component Test, and Scope Multimeter to diagnose and locate the source of problem, select **Information** on the Home screen to link to resources that help you fix the problem and get the vehicle back in service (Figure 8-1).



Figure 8-1 Sample Home screen Information icon

A built in repair information database is available for the United Kingdom and Australia. Simply select the Repair information toolbar icon to start the program. A brief description of what type of information is available and how to navigate through the data follows below.

The repair information displays in the Windows Internet Explorer web browser, and as a result may open a standard Internet Explorer dialog box when certain selections are made. For example; when returning to a previously visited page, a message similar to Figure 8-2 may display.



Figure 8-2 Sample Internet Explorer dialog box

Although these dialog boxes are typically of little concern, a response is required to continue. In the above example, the choices presented offer the following results:

- **Retry**—advances to the selected page. If the VERUS is actively connected to the internet the software checks for any recent updates to the data presented on the target page. When updates are found, the most recent information available, rather than what was shown the last time the page was visited, displays when the page opens.
- **Cancel**—returns to the previous page.

This type of dialog box is designed to prevent your personal information from being posted to a non-secure website. The VERUS software does not involve personal information or purchases, therefore website security is not an issue. You can safely select **Retry** to continue.

8.1 Vehicle Identification

What happens when the Information icon is selected from the VERUS Home screen depends upon whether or not a test vehicle has been identified:

- With no active vehicle, the first in a series of vehicle identification screens that allow you to select the year, make, model, and other pertinent information for the test vehicle opens.
- With an active vehicle, the Information main menu, which allows you to select different types of tests, opens ([Figure 8-3](#)).

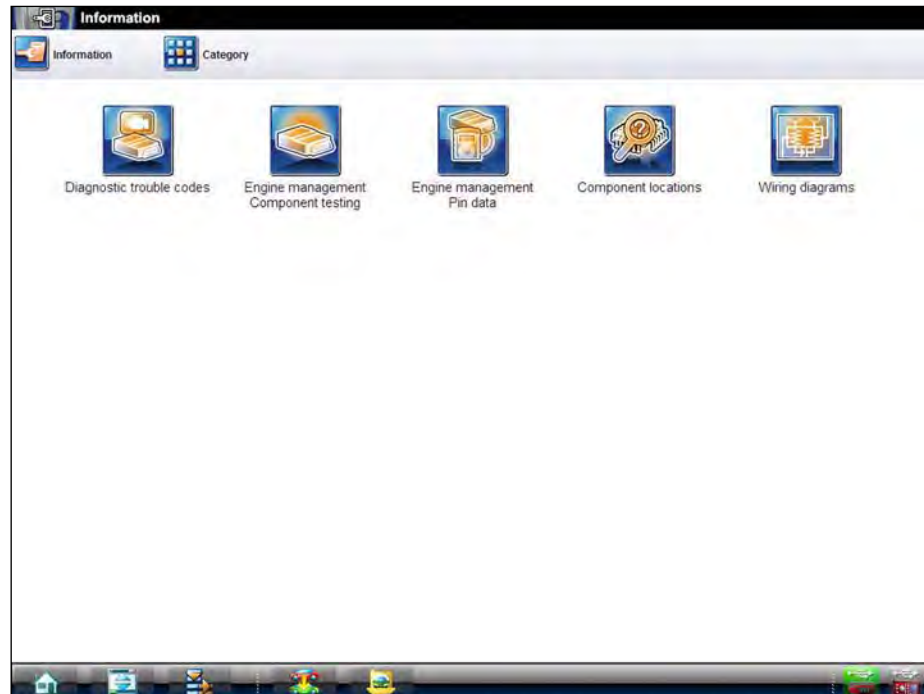

Figure 8-3 Sample information main menu

The Information main menu options are detailed in the table below:

Table 8-1 Information icon descriptions





Name	Icon	Description
Diagnostic Trouble Codes		Provides information on retrieving, diagnosing, and repairing diagnostic trouble code (DTC) problems. See “Diagnostic Trouble Codes” on page 105.
Engine Management Component Testing		Provides information on performing tests on engine management components. See “Engine Management Component Testing” on page 107.
Engine Management Pin Data		Provides connector diagrams and pin assignment information for engine management systems. See “Engine Management Pin Data” on page 110.

Table 8-1 Information icon descriptions

Name	Icon	Description
Component Locations		Provides graphics and text for locating various vehicle components. See “Component Locations” on page 111.
Wiring Diagrams		Provides instant access to a wiring diagram for the test vehicle. See “Wiring Diagrams” on page 113.



NOTE:

Anytime a Category icon appears in the upper toolbar portion of the screen while navigating through Information, selecting it returns you to the Information home page (Figure 8-3).

8.2 Diagnostic Trouble Codes

Information for locating, diagnosing, and repairing diagnostic trouble code (DTC) problems is located here. Information is specific to the identified vehicle.



To access DTC information:

1. Double click the **Diagnostic Trouble Codes** icon.
A Data Category list displays (Figure 8-4). The number of categories available varies by make, model, and year. Select Cancel at the bottom of the list to return to the previous screen.

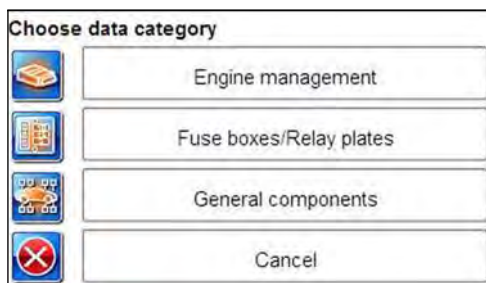

Figure 8-4 Sample DTC category list

2. Select a category on the list to select it and open the Diagnostic Trouble Codes screen.



NOTE:

Additional information about the test vehicle is needed to ensure the correct information displays in some instances. If so, a window with a selectable list of options opens. Highlight the correct option on the list, then select the **Accept** icon to continue.

8.2.1 Diagnostic Trouble Codes Screen

The DTC screen is divided into two main fields; the selection field on the left hand side and the information field on the right hand side. The selection field, which determines what information is shown in the information field, typically offers the following choices:

- Data Link Connector—this is the default screen when diagnostic trouble codes is selected. The location of the data link connector (DLC) is shown in a graphic below the selection field.
- General Information—provides information such as common terminology, general test conditions, and standard fault descriptions.
- Accessing and Erasing—provides information on retrieving and clearing DTCs from the electronic control module (ECM).
- Trouble Code Identification—provides a definition and probable cause for DTCs.



NOTE:

There may be more than one Trouble Code Identification selection available, as the information is broken down into subcategories when there is a large amount of data or there are different types of codes available.

A search feature, available for all of the trouble code identification selections, is available to help you quickly find the code information you need.

8.2.2 Printing Diagnostic Trouble Code Information

All or part of the diagnostic trouble code information can be sent to a printer.



To print diagnostic trouble code information:

1. Select the **Print** icon on the toolbar, see [“Toolbar” on page 114](#) for details. The Print Options window opens ([Figure 8-5](#)).

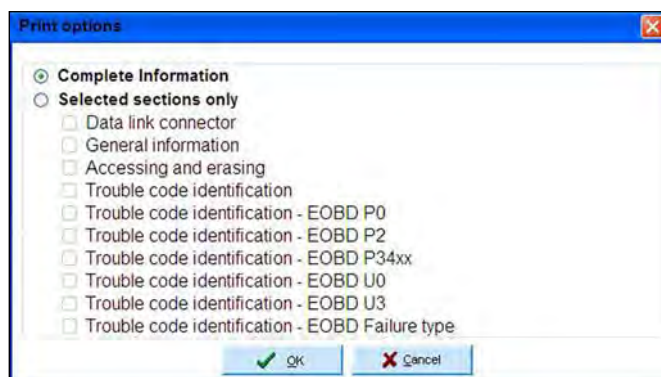

Figure 8-5 Sample Print Options window

2. Select the check boxes for the options to be printed.
3. Select **OK** to send the selected information to a printer, select **Cancel** to close the Print Options window without printing.

Select the **Information - Vehicle ID** icon in the upper-left portion of the screen at any time to end the current session and return to the vehicle identification screen.

8.3 Engine Management Component Testing

Procedures for diagnosing, evaluating, and testing engine management system components are found in this section. Information is specific to the identified vehicle.



To access engine management component testing:

1. Double click the **Engine Management Component Testing** icon.

A category list displays (Figure 8-4). The number of categories available varies by make, model, and year. Select Cancel at the bottom of the list to return to the previous screen.

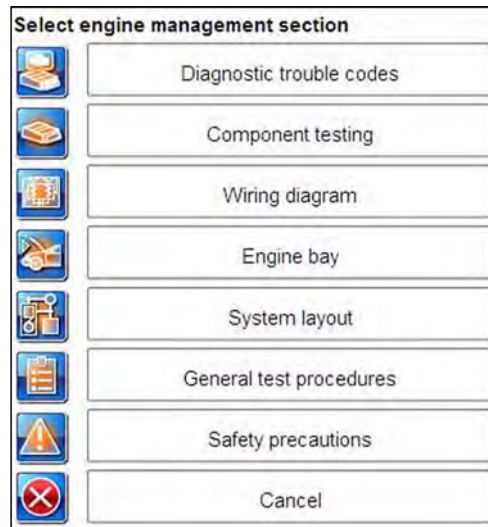

Figure 8-6 Sample engine management component testing category list

2. Select a category on the list to select it.
The selected category screen opens.

Although category availability varies by vehicle, typical choices include:

- Diagnostic Trouble Codes—this is the same information available from the Diagnostic Trouble Codes icon, see [“Diagnostic Trouble Codes” on page 105](#) for details.
- Component Testing—provides detailed procedures and specifications for testing system components and performing service operations.
- Wiring Diagram—this is the same information available from the Wiring Diagrams icon, see [“Wiring Diagrams” on page 113](#) for details.
- Engine Bay—this information is also available from the Component Locations icon, see [“Component Locations” on page 111](#) for details.
- System Layout—provides a graphical description of the engine management system design.
- General Test Procedures—provides common test procedures and service guidelines that apply to all makes and models.
- Safety Precautions—lists safety precautions that must be adhered to protect yourself, bystanders, the vehicle and equipment from accidental injury or damage.

8.3.1 Engine Management Component Testing Screen

There are three main screen fields for engine management component testing (Figure 8-7):

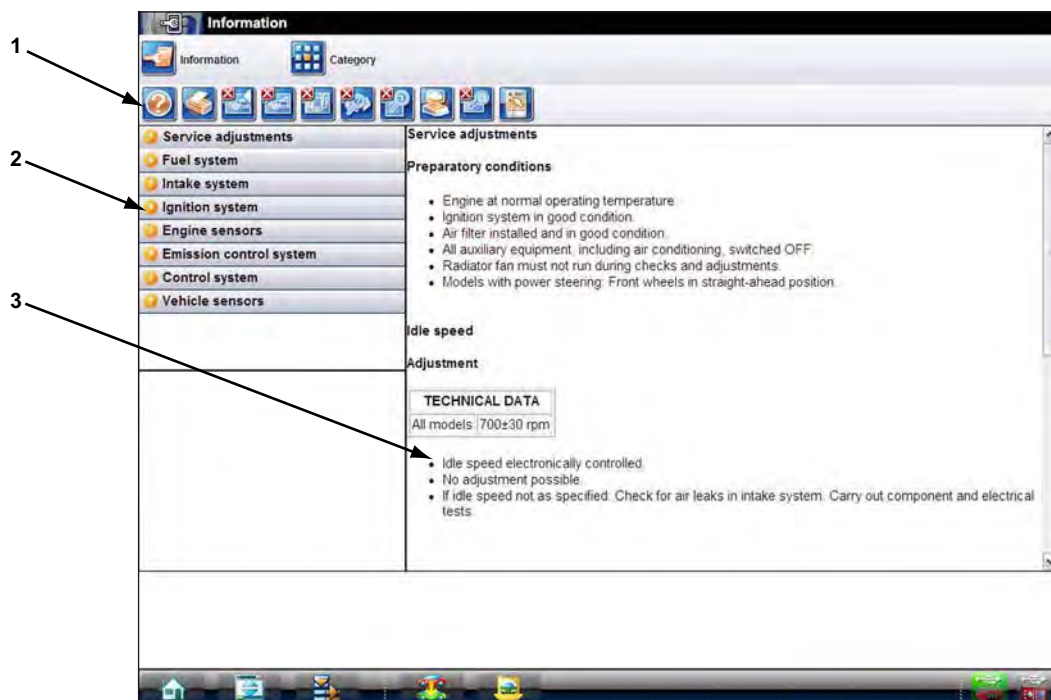

- 1— **Toolbar**—located at the top of the screen, the toolbar allows you to quickly navigate between different functions and operations. See [“Toolbar” on page 108](#).
- 2— **Component Test Menu**—located on the left-hand side of the screen, the menu shows what information is available and also selects what displays in the information field. See [“Component Test Menu” on page 109](#).
- 3— **Component Test Information**—located on the left-hand side of the screen, displays an article that provides procedures for testing system components. See [“Component Test Information” on page 110](#).

Figure 8-7 Sample component testing screen

Toolbar

Toolbar icons allow you to quickly move between operations and functions. The number of icons that are active depend upon what information is currently being displayed. An inactive icon is

indicated by an “X” in the upper-left corner of the icon. Icon operation is described in the table below.

Table 8-2 Information icon descriptions

Name	Icon	Description
Help		Opens a help file that details tool operations.
Print		Opens a print dialog box that allows you to add customer information to the displayed article and send it to a printer.
Previous Illustration		Returns to show the previous illustration in the displayed article.
Next Illustration		Advances to show the next illustration in the displayed article.
Wiring Diagram		Opens a wiring diagram for the test vehicle. This is the same diagram available from the Wiring Diagrams module, see “Wiring Diagrams” on page 113 for details.
Component Locator		Opens an engine bay component location illustration. This is the same illustration available from the Component Locations module, see “Component Locations” on page 111 for details.
Zoom Illustration		Opens a larger (full-screen) version of the illustration currently shown in the menu panel. Select anywhere on the illustration to return to the original screen.
Diagnostic Trouble Codes		Opens the Diagnostic Trouble Codes module, see “Diagnostic Trouble Codes” on page 105 for details.
Colour Code Key		Opens a key to wiring diagram colour coding in a separate window. Select the “X” in the upper-right corner of the window to close it.
Category List		Opens the Engine Management Component Testing category list, this is the same list that displays when you first enter component testing.

Component Test Menu

The component test menu on the left side of the screen lists what articles are available in the upper portion of the field and displays illustrations for the selected article in the lower portion of the field. Selecting a menu item to select it loads the related article into the right-hand field of the screen, and also opens a submenu below the original menu item.

Selecting a submenu item with the stylus advances the right-hand field to that point in the article. Selecting an expanded main menu item closes the submenu.

Component Test Information

Articles that display on the right side of the component test screen contain detailed test procedures, specifications, and other resource information used to make repairs. Illustrations related to the article are shown in the lower portion of the menu field. A scroll bar appears along the right margin of the field for lengthily article that do not fit on a single screen. Selecting an item from the submenu takes you directly to that point of the article.

8.4 Engine Management Pin Data

An engine control module (ECM) connector diagram with pin assignments and test conditions are contained in this section. Double click the Engine Management Pin Data icon to view the information (Figure 8-8).

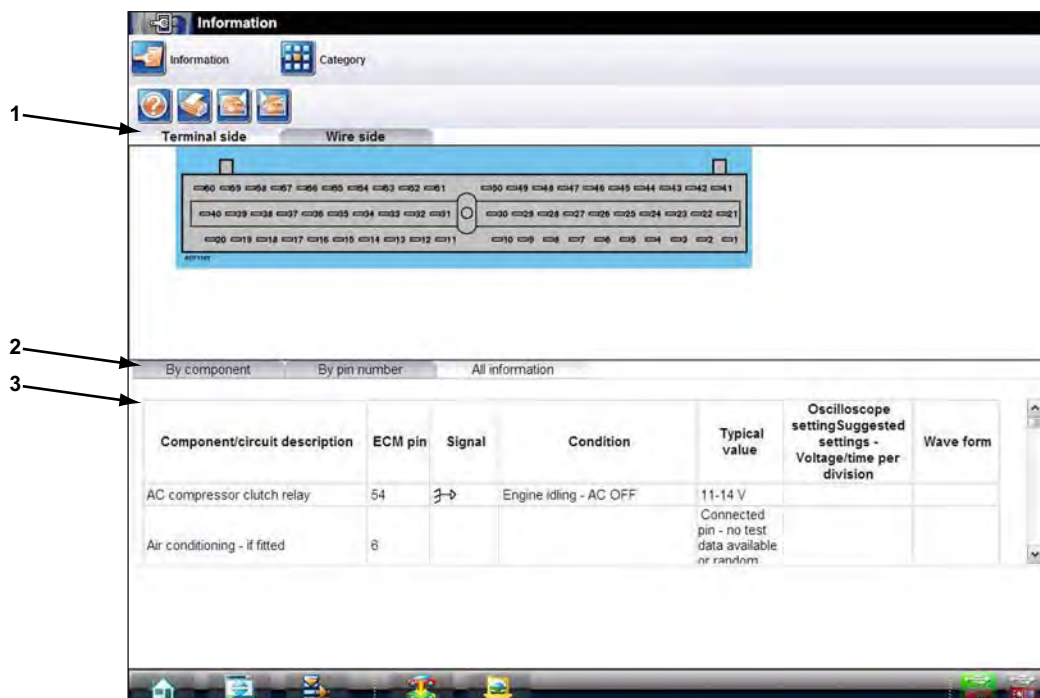

- 1— View Tabs
- 2— Information Tabs
- 3— Component Selection

Figure 8-8 Sample ECM Pin Data screen

A table in the lower portion of the screen displays the available pin data. Several shortcuts are available from the table:

- If the name of the component in the Component/Circuit Description column is underlined, selecting the name with the stylus opens the component testing article for that item. See “Engine Management Component Testing” on page 107 for additional information.
- If a number appears in the Waveform column, a “known good” sample waveform is available for viewing. Select the number with the stylus and the waveform opens in a separate window. Select anywhere in the waveform window to close it.

8.4.1 View Tabs

The View Tabs determine which perspective of the ECM connector diagram displays. Two choices are available:

- Terminal Side—shows the connector as if it were disconnected from the ECM and you are looking into the face (open terminal side) of the connector.
- Wire Side—shows the connector as if were connected to the ECM and you are looking at the wiring harness side of the connector. Commonly referred to as the “backprobing” view.

Use the touch screen to select.

8.4.2 Information Tabs

The Information Tabs determine how the ECM connector pin information displays. There are three information options:

- By Component—only the data for the selected component is shown in the table. Component selections are listed by name only in alphabetical order, there are no pin numbers on the list.
- By Pin Number—only the data for the selected pin is shown in the table. Component selections are listed by pin number only in numerically ascending order, there are no component descriptions on the list.
- All Information—all of the available pin data displays in the table sorted alphabetically by component name. A scroll bar at the right of the table is used to navigate through the data.

Use the touch screen to select.

8.4.3 Component Selection

This field, which only displays when the By Component or By Pin Number tab is selected, is used to select what data displays in the table.



To use component selection:

1. Select anywhere in the **Component Selection** field with the stylus.
The menu, sorted by component or pin as determined by the Information Tab selected, opens.
2. Select a menu item with the stylus.
The menu closes and the data for the selected item is now shown in the table. On the connector diagram, the pin for the selected item appears in red.

8.5 Component Locations

This section contains graphic depictions and textual references as to where specific components are located on the test vehicle. Selecting the **Component Locations** icon on the home page opens a data category menu.

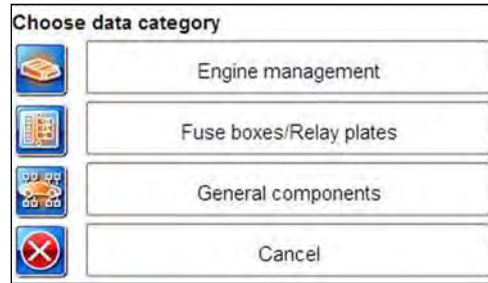
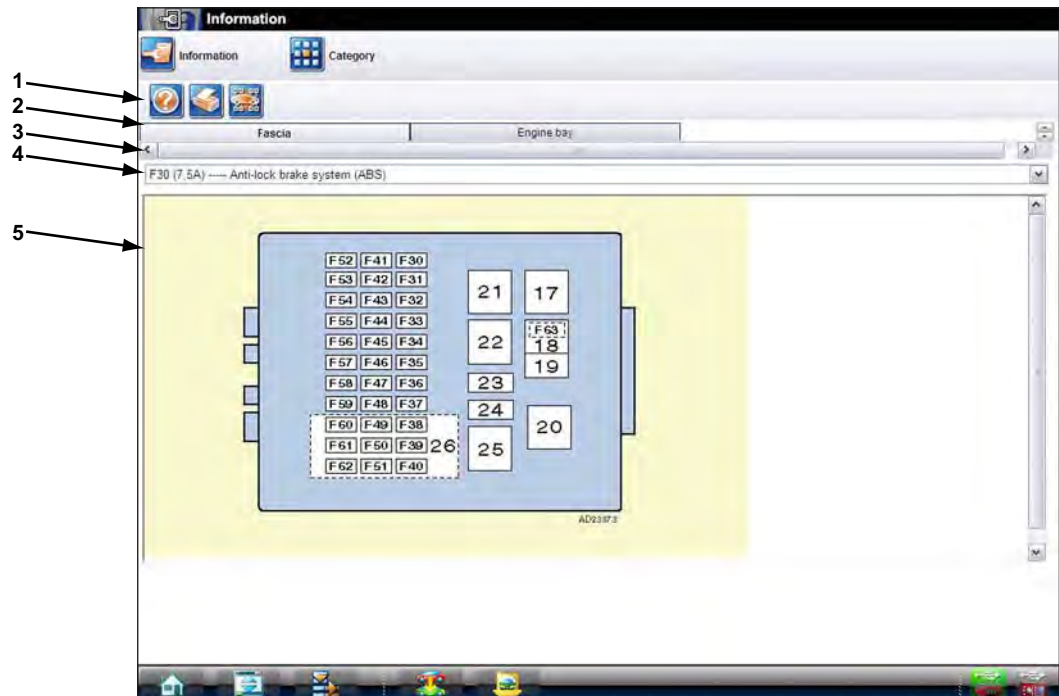

Figure 8-9 Sample Component Locations category menu

The categories vary, but typically include:

- Engine Management—provides engine control system component location information.
- Antilock Brake Systems—provides ABS component location information.
- Fuse Boxes/Relay Plates—provides power distribution component location information.
- General Components—provides major component location information for the entire vehicle.
- Airbags—provides supplemental restraint system component location information.
- Cancel—returns the display to the home page.

Component location screens vary somewhat by category, but all of them display the selected diagram in the lower portion of the screen (Figure 8-10).



- 1— Toolbar
- 2— Tabs
- 3— Scroll Bar
- 4— Component Selection Menu
- 5— Location Diagram

Figure 8-10 Sample fuse box/relay plate screen

A toolbar, located above the diagram, offers shortcuts to certain operations. Toolbar icon operations are the same as for Engine management Component Testing, see “[Toolbar](#)” on [page 108](#) for descriptions. which toolbar icons display varies by category.

A component selection menu appears between the toolbar and the main screen on some diagrams. Select the listed item to open the menu and use the stylus to make selections. The menu collapses once an item is selected and a red highlight marks the location of the selected item on the diagram.

When viewing Fuse Boxes/Relay Plates diagrams a series of tabs located underneath the toolbar determines which fuse box or relay plate is displayed. A scroll bar moves the tabs left and right if there are more tabs than what will fit on a single screen.

8.6 Wiring Diagrams

This home page selection contains system wiring diagrams for the identified test vehicle, the number of diagrams available varies by year and model. Selecting the Wiring Diagrams icon opens a data category menu. Select a menu item with the stylus to open the wiring diagram. A typical wiring diagram screen is shown in [Figure 8-11](#).

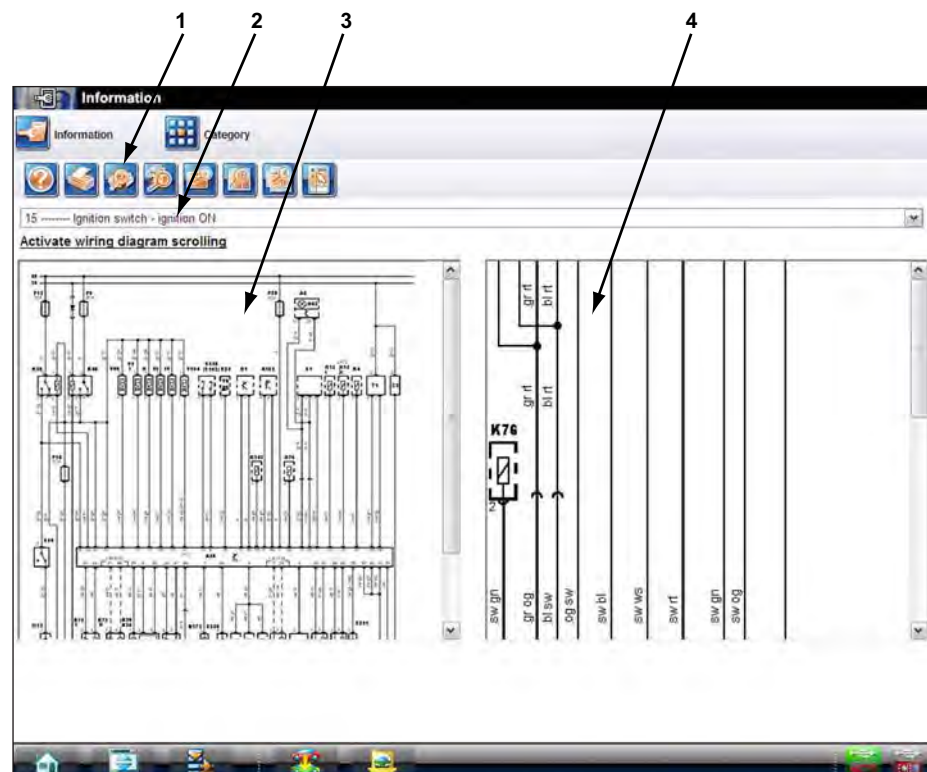



- 1— Toolbar
- 2— Component Selection Menu
- 3— Full-width Window
- 4— Magnified Window

Figure 8-11 Sample wiring diagram screen

8.6.1 Toolbar

Most of the toolbar icons are the same as for Engine management Component Testing, see “[Toolbar](#)” on page 108 for descriptions. However, there are some icons that only appear on wiring diagrams. These are explained in the table below.

Table 8-3 Information icon descriptions

Name	Icon	Description
ECM Harness Connector		Opens an ECM harness connector diagram in a separate window. Only the connector displays, pin data is not shown.
Full Size		Expands the wiring diagram to full-page size, scroll bars appear for moving up and down and left and right through the diagram.
Fit to Window		Cancels the full-size diagram and return to the split-screen display.

8.6.2 Component Selection Menu

The Component Selection menu is used to locate a particular item on the wiring diagram. Select the listed item to open the menu and use the stylus to make selections. The menu collapses once an item is selected and a red highlight marks the location of the selected item on the full-width diagram shown on the left-side of the screen.

8.6.3 Full-width Window

The window in the right-hand panel of the main screen provides a reduced (full-width) view of the wiring diagram. A scroll bar to the right of the window moves the diagram up and down on the screen. The full-width diagram is a navigational aid for locating elements on the magnified diagram in the right hand window. Use the full-width diagram as follows:

- Touch any portion of the full-width diagram with the stylus and that area of the wiring diagram displays in the magnified window.
- Touching a component on the full-width diagram with the stylus highlights that component in red, displays its name in the component selection menu window, and displays that portion of the wiring diagram in the magnified window.
- Move the full-width diagram scroll bar and the magnified window scrolls as well.

8.6.4 Magnified Window

The window in the right-hand panel of the main screen provides a magnified view of a small portion of the wiring diagram. Use this window to read details on the wiring diagram. Select the **Full Size** icon on the toolbar to view the complete diagram.

Vehicle History refers to any work in progress, such as a repair order, estimate or invoice, that has customer, vehicle, and repair information for a vehicle in your shop. The Vehicle History is the starting point for using the VERUS system.

The Scan Module and Guided Component Test software gets vehicle information from the Vehicle History, and can only start after a Vehicle History is opened.

9.1 Screen Layout

There are two main parts to the Vehicle History screen:



1— **Vehicle History Toolbar**—lets you manage the vehicle data

2— **Main Body**—lists all open Vehicle History records

Figure 9-1 Sample Vehicle History screen

9.1.1 Vehicle History Main Body

The main body of the screen lists all of the available Vehicle History items. By default, items are shown in the order in which they are entered. However, you can resort them by any of the categories shown as column headings. You can also resize the individual columns.



To sort Vehicle History items:

1. Select a category heading.
The listed items resort according to the selected category. A triangle appears alongside the name of the column that was used for the sort.
2. Select the triangle in the heading to reverse the sort order.









To resize a Vehicle History column:

1. Touch the line separating two columns.
A line with arrowheads appears to show the column is ready for resizing.
2. Drag the line left or right to increase or decrease the column width.

9.1.2 Vehicle History Toolbar

The table below gives brief descriptions of the control icons on the toolbar:

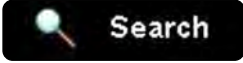
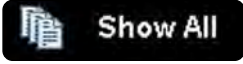
Table 9-1 *Toolbar icons*

Name	Icon	Description
Back		Returns to the previously viewed screen.
Activate		Loads the highlighted vehicle history.
View		Opens the worksheet for the currently highlighted vehicle history.
Delete		Erases the currently highlighted vehicle history.
Search		Opens a window that allows you to locate a particular vehicle history.
Show All		Available only after a search, use to return to a complete Vehicle History list.
Settings		Opens a window that allows you to configure which fields display on main Vehicle History screen.

Activate

Use this icon to load an existing vehicle history when servicing a vehicle that you have previously worked on. VERUS uses the identification characteristics stored in the vehicle history to load the correct database, so you do not need to identify the vehicle to begin testing.



To activate a vehicle:

1. Locate and highlight the desired Vehicle History in the main body of the screen.
2. Select **Activate** on the Vehicle History toolbar.
The Activate icon is removed from the toolbar once a vehicle has been selected.
3. Select the **Home** icon on the VERUS toolbar.
The VERUS Home screen displays and with the activated vehicle shown on the toolbar.
4. Select any Function icon on the Home screen to begin testing.

View

Use this selection to open edit, add notes, and print the work sheet for an existing Vehicle History.



To modify an existing Vehicle History:

1. Highlight the Vehicle History to be opened in the main body of the screen.
2. Select **View** on the Vehicle History toolbar.
The worksheet for the selected vehicle opens, and there are now Back and Save & Close icons available on the toolbar.

Figure 9-2 Sample vehicle history worksheet

**NOTE:**

The virtual keyboard automatically opens the first time you touch within one of the data fields.

3. Use the virtual keyboard to enter information in the data fields.
4. Select **Save & Close** on the toolbar to save the changes you made and return to the Vehicle History screen. Use the toolbar **Back** icon to return without saving the changes.

Delete

Use the Delete icon to remove unwanted items from the Vehicle History list. Simply highlight the item to remove, then select **Delete**.

Search

Selecting Search opens a dialog box that allows you to search Vehicle History items by category.

You can search for data in the following categories:

- Year
- Make
- Model
- Color
- Customer
- License
- State
- Technician

**To search:**

1. Select **Search** on the Vehicle History toolbar to open the search window.
2. Select within the text field of the search window to open the virtual keyboard ([Figure 9-3](#)).

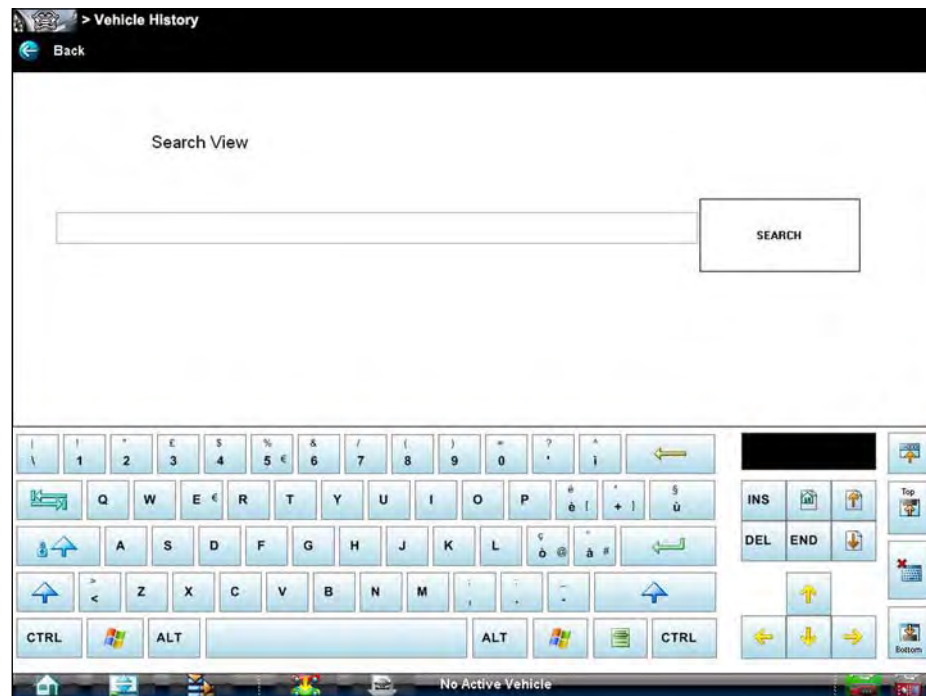

Figure 9-3 Sample Search dialog box

3. Enter the search criteria using the keyboard. There is no need to identify the category, just enter the search item.
4. Select **Search** twice. The first tap closes the keyboard, the second tap starts the search. The display returns to the Vehicle History screen with only the records fitting the search criteria showing.
5. Select **Show All** on the toolbar to restore the complete Vehicle History list.

Settings

Use Settings to determine which categories of information display in the main body of the Vehicle History screen. Selecting the Settings icon opens a dialog box.



To change Settings:

1. Select **Settings** on the Vehicle History toolbar to open the dialog box.

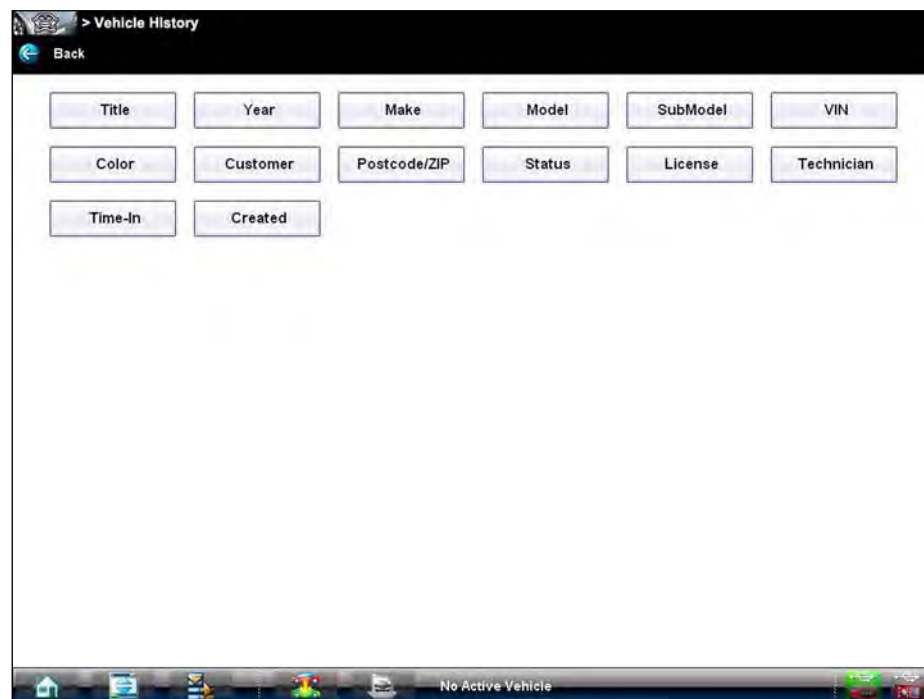

Figure 9-4 Sample Settings dialog box.

2. Select to highlight the categories that you do not want to display on the main screen, remember:
 - Items that are highlighted do not display
 - Items that are not highlighted display
3. Select **OK** on the toolbar to implement the changes, select **Cancel** to disregard the changes. The dialog box closes and the screen updates.

The Data Manager module is used to store, sort, and review saved files. Most operations are controlled through the toolbar.

10.1 Screen Layout

Select Data Manager on the Module toolbar to open the file system. Use the toolbar at the top of the screen to navigate through the data. The folders panel below the toolbar displays the contents of the Windows “My Documents” folder. The information panel on the lower-left portion of the screen shows a summary of the saved file when available, and the preview panel on the lower right displays an image if the selected file is a graphic.

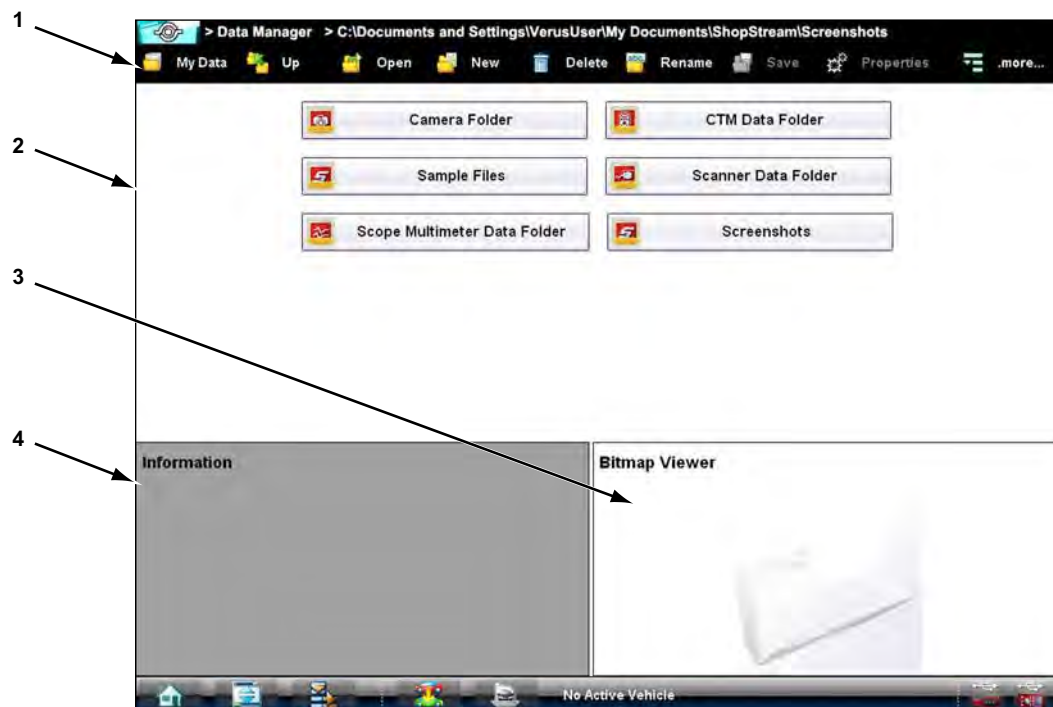





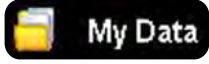

- 1— Data Manager Toolbar
- 2— Folders Panel
- 3— Preview Panel
- 4— Information Panel

Figure 10-1 Sample Data Manager main screen

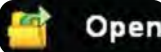
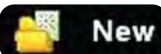
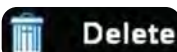
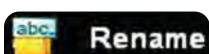
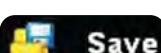
The Data Manager module is used to store, sort, and review saved files. Most operations are controlled through the toolbar. Toolbar functions in the table below and explained in the following sections:

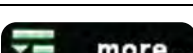
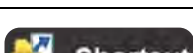
Table 10-1 *Data Manager toolbar icons*

Name	Icon	Description
My Data	 My Data	Returns the main screen to the original (My Documents) view.
Up	 Up	Moves the items displayed in the folders panel up one level in the file structure.
Open	 Open	Opens the highlighted folder or file.
New	 New	Creates a new folder.
Delete	 Delete	Moves the highlighted file or folder to the Recycle Bin.
Rename	 Rename	Opens a dialog box and virtual keyboard for renaming the selected file or folder.
Save	 Save	Saves the selected file.
Properties	 Properties	Opens a dialog box and virtual keyboard for renaming the selected file or folder.
More	 .more...	Opens a menu of additional options.
Shortcut	 Shortcut	Creates a link, or shortcut, to the selected file on the Data Manager main screen.
Email	 Email	Attaches the selected file to a new email.

10.1.1 My Data

The My Data icon is a shortcut that quickly returns you to the main Data Manager screen. Select the icon at any time to instantly return. Note the location of the page being viewed is shown near the top of the screen just below the toolbar.

10.1.2 Open

The Open icon is only active (displays in color) when an item in the folders panel is highlighted.



To open a folder:

1. Highlight the file to open in the folders panel.
2. Select the **Open** icon to load the highlighted file.



Figure 10-2 Sample open folder showing information

The screen advances and the contents of the open folder are shown in folders panel. Highlight an item in the folders panel and the information or preview displays if available (Figure 10-2).

3. To exit the current folder:
 - Select **My Data** on the toolbar to return to the main Data Manager screen.
 - Select **More > Up** on the toolbar to return to the previous page.

10.1.3 New

The New icon allows you to create a new folder. This option is only available when the icon displays in color.



To create a new folder:

1. Select the **New** icon on the toolbar.
The New Folder Name dialog box opens (Figure 10-3).
2. Touch the entry field on the dialog box to open the virtual keyboard.
3. Type a name for the new folder using the virtual keyboard.
4. Select the **OK** icon to create the new folder and return to the previous page. The **Cancel** icon returns you to the previous page without creating a new folder.

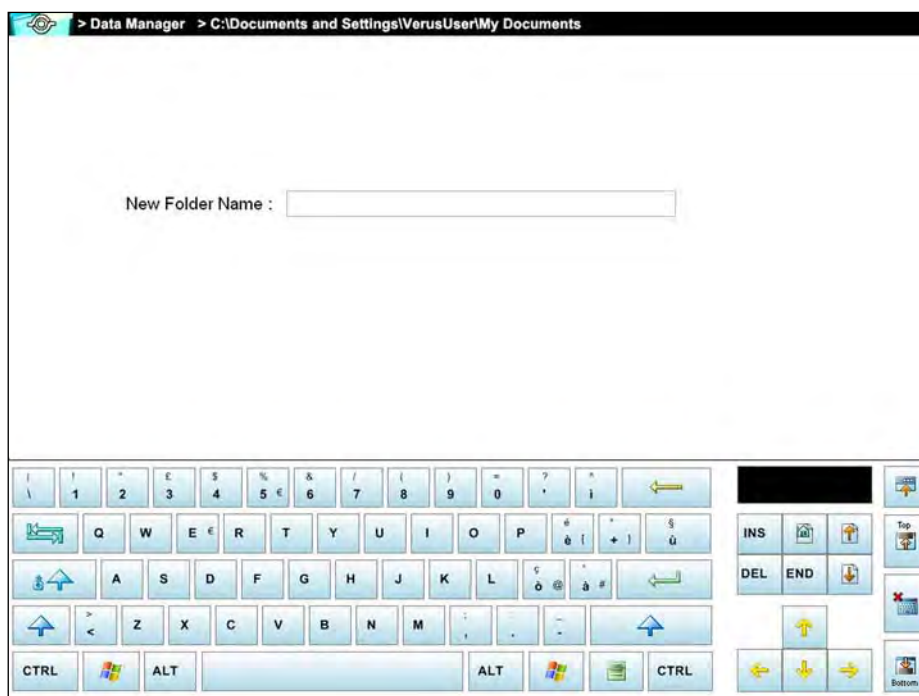

Figure 10-3 Sample New Folder name dialog box

10.1.4 Delete

The Delete icon moves folders or items within folders to the Recycle Bin.



To delete an item:

1. Touch to highlight the item or folder to be deleted.
2. Select the **Delete** icon on the toolbar.
A confirmation message displays (Figure 10-4).
3. Select **OK** to delete the selected item and return to the previous page. The **Cancel** icon returns you to the previous page without deleting the selected item.

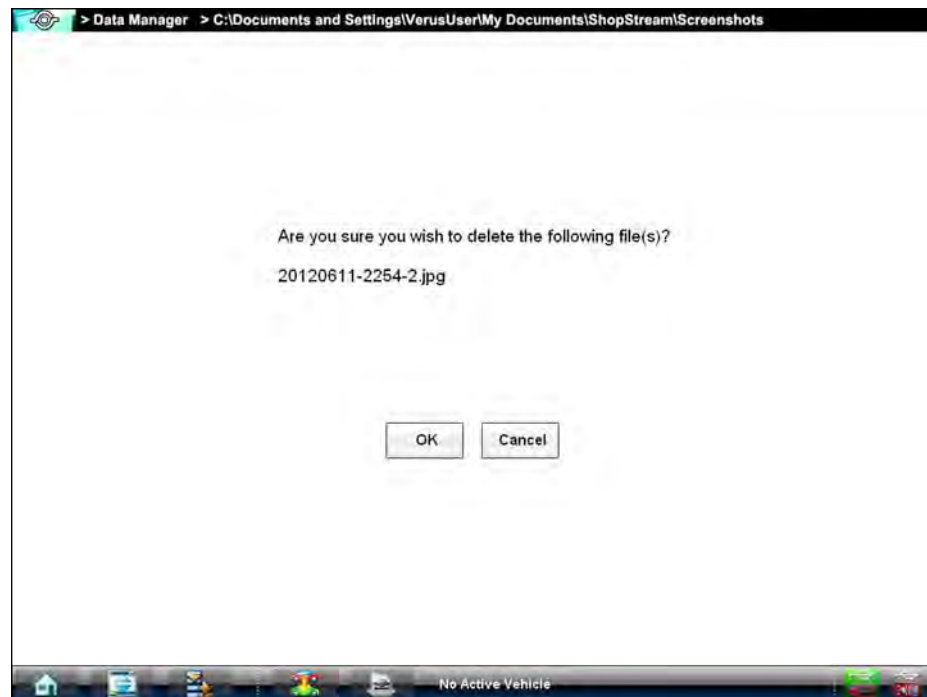

Figure 10-4 Sample delete confirmation message

10.1.5 Rename

The Rename icon allows you to change the name of a folder or items within a folder.



To rename an item:

1. Touch to highlight the item or folder to be renamed.
2. Select the **Rename** icon on the toolbar.

The New Name dialog box opens (Figure 10-3).

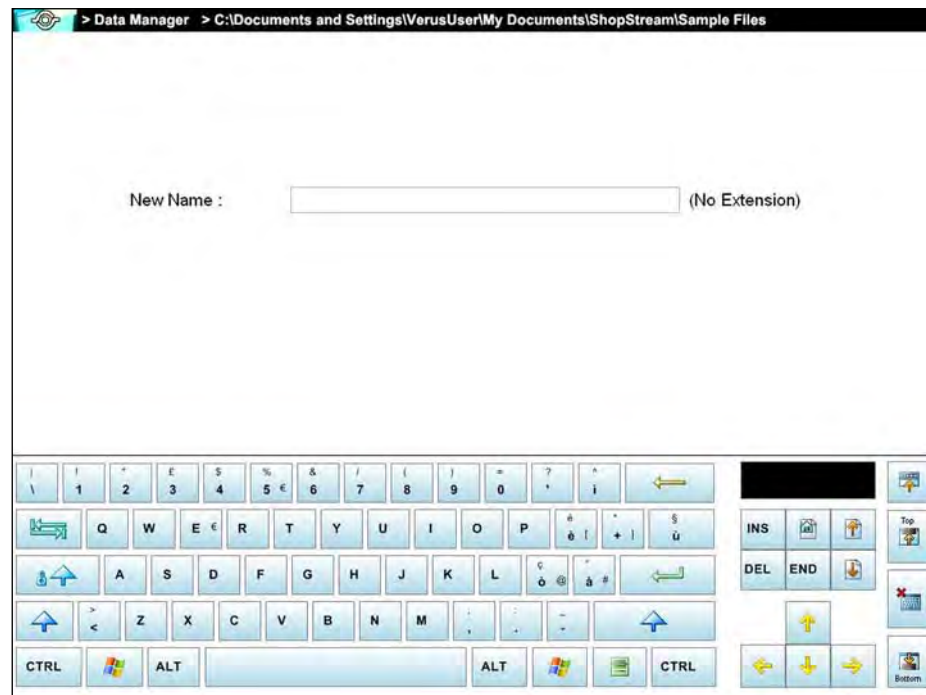

Figure 10-5 Sample new name dialog box

3. Touch the entry field on the dialog box to open the virtual keyboard.
4. Type the new name into the entry field using the virtual keyboard.
5. Select the **OK** icon to change the name and return to the previous page. The **Cancel** icon returns you to the previous page without changing the name.

10.1.6 Properties

The Properties icon function allows you to change the name and assign identifying attributes to saved Scope Multimeter files. Operation is similar to renaming a file as discussed above, except there are additional fields for entering descriptive information.



To assign properties to an item:

1. Highlight the item or folder.
2. Select the **Properties** icon on the toolbar.

The Properties dialog box and the virtual keyboard open (Figure 10-6).

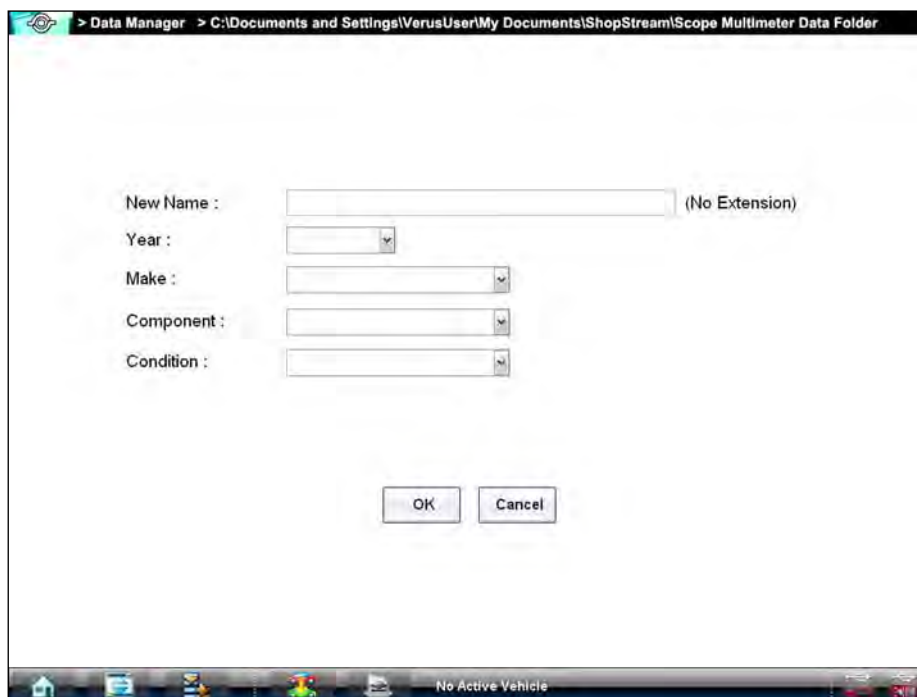

Figure 10-6 Sample Properties dialog box shown without the virtual keyboard

3. Type a new name into the field using the virtual keyboard if you want to rename the file.
4. Use either the virtual keyboard or the dropdown menus to fill in the Year, Make, Component, and Condition fields.
5. Select the **OK** icon to change the name and return to the previous page. The **Cancel** icon returns you to the previous page without changing the name.

10.1.7 More

Selecting the More icon opens a dropdown menu with two options:

- **Shortcut**—creates a shortcut to the highlighted item. A confirmation message that includes the address of where the shortcut will be installed displays when this option is selected.
- **Email**—opens a new e-mail message with the selected file attached. The Diagnostic Tool must have an active e-mail account to use this feature.

10.2 Saved File Structure

The Diagnostic Suite automatically creates folders to manage saved files. Whenever 60 files are saved into any of the Data Manager menu option folders, a new folder is created. Folders may contain files for a day, week, month, or a year. An Older folder, when available, goes to the next higher level in the files structure menu (Figure 10-7).

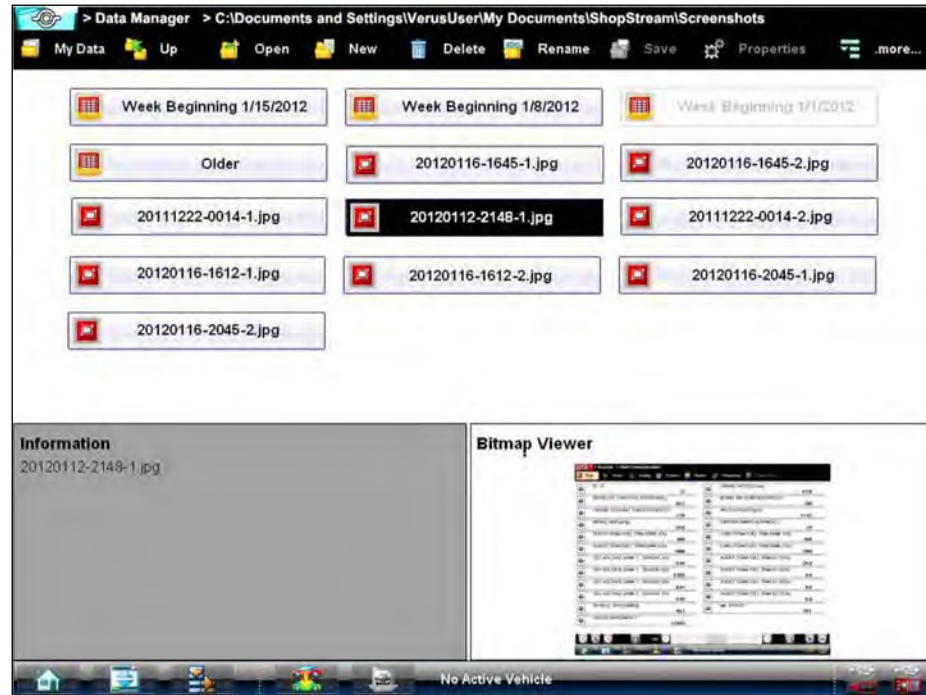

Figure 10-7 Sample saved file folder structure

Selecting Help from the Home screen opens this manual in a dedicated screen viewer. Navigate through the file either by gesture scrolling on the touch screen, or with the scroll bar along the right edge of the viewing screen. A left-to-right scroll bar appears at the bottom of the screen when magnification is increased.

All listings in the Contents and Index are active links. Select an entry with the stylus to go directly to that point of the document. Additional links within the text, shown in blue-colored type, also take you to the referenced section of the manual.

11.1 Using the Help Toolbar

A simple toolbar at the top of the screen is used to adjust screen magnification and to exit Help:

Table 11-1 Help toolbar icons (sheet 1 of 2)







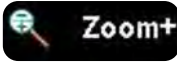
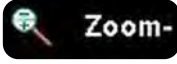

Name	Icon	Description
Back		Closes the help file and returns you to the previously viewed screen.
Zoom +		Incrementally increases the screen magnification.
Zoom –		Incrementally decreases the screen magnification.
Reset		Restores the default screen magnification.
Previous Page		Moves back one page in the document.
Page Counter		Shows the current page over the total number of pages in the document.
Next Page		Moves forward one page in the document.
More		Opens a menu of the additional options shown below.

Table 11-1 Help toolbar icons (sheet 2 of 2)

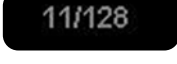
Name	Icon	Description
	Hide TOC	
		Closes the contents and search column so the document fills the screen.
	Show TOC	
		Opens the contents and search column if they have been hidden.
Exit		Closes the help file, and any other open modules, and returns you to the Home screen.

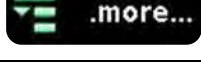
Selecting System Settings from the Home screen opens a menu with two options:

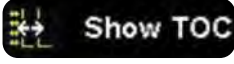
- "Paired Devices"
- "Shop Information"

Paired Devices allows you to check the status of and to pair wireless devices, such as the Scan Module, to the Diagnostic Tool. Shop Information allows you to create and edit a personalized header that is included on printed documents.

12.1 Paired Devices

The wireless Scan Module makes vehicle data readily available on the Diagnostic Tool while working anywhere on or around the vehicle. Before use, wireless units must be "paired" in order to create a communications network between them. Information about modules paired to the Diagnostic Tool can be found by selecting System Settings from the Home screen.



To check paired module details:

1. Select the **System Settings** icon on the Home screen.
2. Select the **Paired Devices** option on the menu.

The paired devices screen opens ([Figure 12-1](#)).

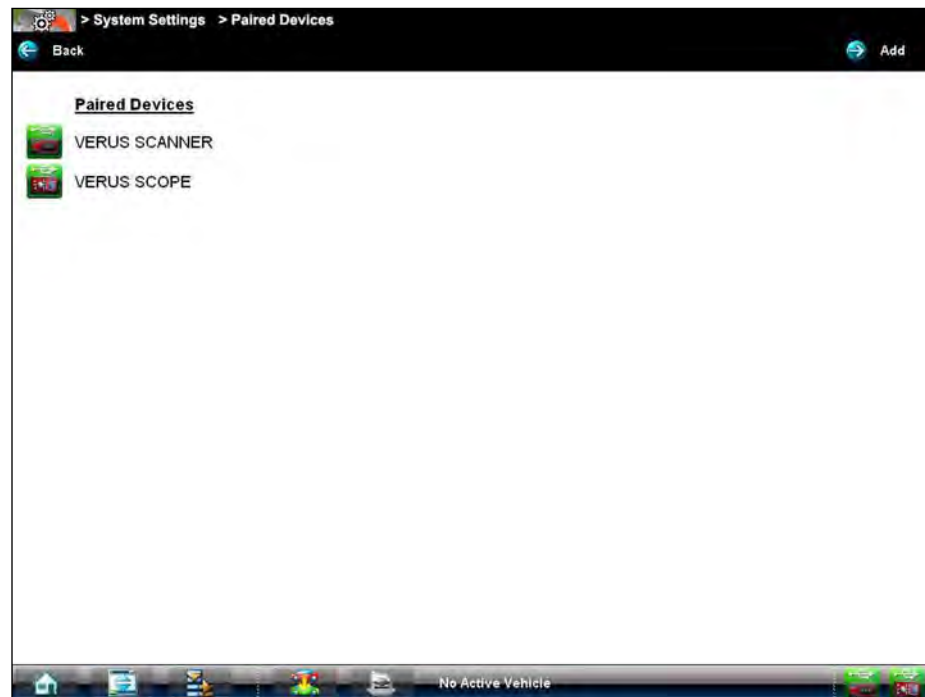

Figure 12-1 Sample Paired Devices screen

The Paired Devices screen shows the type and a partial serial number for all of the modules synchronized to the Diagnostic Tool, and whether or not there is an active communications link between the units.

12.1.1 Pairing the Wireless Scan Module

The wireless Scan Module needs to be either connected to a vehicle or connected to a powered USB jack so that it is powered up during the synchronization procedure. Make sure the Diagnostic Tool has a charged battery or is connected to an AC power supply.



To pair the Scan Module with the Diagnostic Tool:

1. Power on the VERUS Diagnostic Tool.
2. Connect the 26-pin end of the data cable to the Scan Module data cable connector.
3. Connect the 16-pin end of the data cable to a live vehicle data link connector (DLC).
The green vehicle power LED should be illuminated.
4. Select the **System Settings** icon on the Home screen of the Diagnostic Tool.
5. Select **Paired Devices** from the menu.
6. From the Paired Devices screen select **Add** from the toolbar.
7. When prompted select **OK** from the toolbar.

The Diagnostic Tool searches for compatible wireless devices, then displays the results. The Scan Module is listed as "VERUS" plus a partial serial number (Figure 12-2).



Figure 12-2 Sample Scan Module selection

8. Select to select the Scan Module from the search results list.

A search in progress message displays during the pairing procedure (Figure 12-3), the Paired Devices screen (Figure 12-1) displays once the procedure completes.

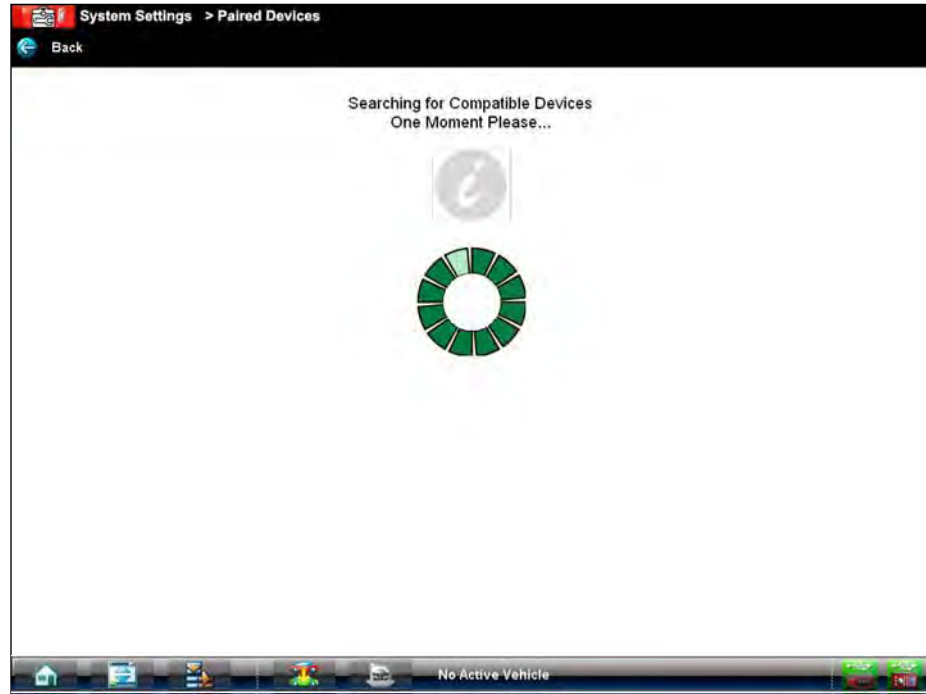

Figure 12-3 Sample pairing in progress message

9. Select the **Home** icon on the VERUS toolbar to return to the Home screen.
10. Disconnect the data cable from the vehicle.

The Scan Module and Diagnostic Tools are now synchronized for wireless communication and should automatically recognize each other when both are powered up.

12.1.2 Shop Information

This option allows you to add personalized shop information that can be included on printed data files. Selecting opens a form that can be filled in using the virtual keyboard. Select OK when the form is complete and the information is saved.



To add Shop Information:

1. From the Home screen select **System Settings**.
2. From the System Settings menu select **Shop Information**.

The Shop Information dialog box opens (Figure 12-4).

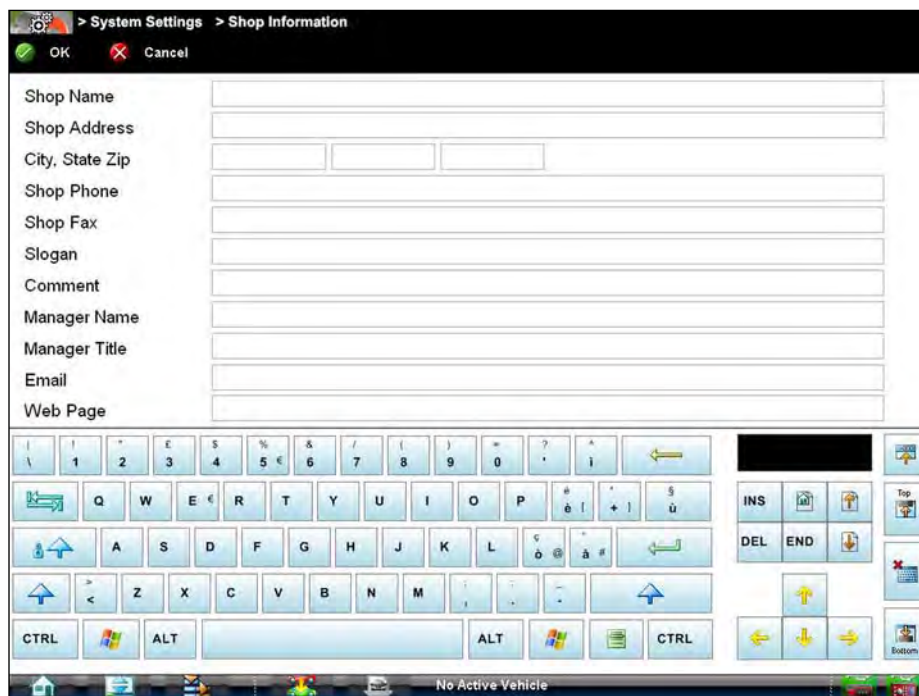

Figure 12-4 Sample Shop Information dialog box

3. Select within any of the information fields and the virtual keyboard opens.
4. Use the virtual keyboard to fill in the Shop Information form.
As an alternative, you can connect a USB keyboard to a USB jack on the Diagnostic Tool and use it to enter information into the form.
5. Close the virtual keyboard and review the information once all the fields have been filled in.
6. Select **OK** from the toolbar to save the Shop Information, or **Cancel** to close the Shop Information dialog box without saving.

The Shop Information screen closes and the screen returns to the System Settings menu.

This section covers how to care for your VERUS Diagnostic Tool.

13.1 Cleaning the Touch Screen

The touch screen can be cleaned with a soft cloth and alcohol or a mild window cleaner.

IMPORTANT:

Do not use any abrasive cleansers or automotive chemicals on the touch screen.

13.2 Calibrating the Touch Screen

The sensitivity and accuracy of the touch screen should be calibrated before you begin using your VERUS Diagnostic Tool. Adjustments can be made to the touch screen calibration to maintain your personal settings. The touch screen can also be set to recognize the stylus being held in place for five seconds as a right-click of a mouse. Both procedures are explained below.

**To calibrate the touch screen:**

1. From the Windows toolbar select **Start > All Programs > Hampshire TSHARC Control Panel** to open the touch screen dialog box (Figure 13-1).

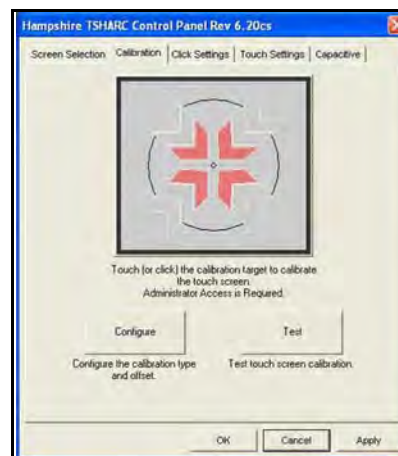

Figure 13-1 Sample Hampshire TSHARC Control Panel window

2. Select the **Calibration** tab.
3. Select **Configure** to open the Calibration Options dialog box.
4. Check **20%** in the Offset field on the right-hand side of the dialog box, **scroll** down and select **20 Point Calibration** on the left-hand side of the screen.

5. Select **OK** to close the Calibration Options dialog box.
6. Select the **Calibration Target** to begin the calibration process.
7. As targets appear on the screen, touch the center of the target with the tip of the stylus. Hold the stylus on the target until the release instruction appears.
8. Select **Accept** to save the settings after touching all of the targets.
9. Select **Apply** to implement the new settings.
10. To make additional adjustments, select other tabs and follow the screen instructions.
11. Select **OK** to close the Control Panel dialog box.

IMPORTANT:

If the touch screen is severely out of calibration use a USB mouse, rather than the stylus, to perform the calibration.

**To set the touch screen for a right mouse click:**

1. From the Windows toolbar select **Start > All Programs > Hampshire TSHARC Control Panel** to open the touch screen dialog box.
2. Select the **Click Settings** tab.
3. Select the **Enable Right Click** check box.
4. Set both the **Right Click Area** and **Right Click Delay** sliders to the middle of the bars.
5. Select **Apply** to implement the new settings.
6. Select **OK** to close the Control Panel dialog box.

13.3 Cleaning and Inspecting the Diagnostic Tool

When using the VERUS Diagnostic Tool, make sure to do the following:

- Check the housing, wiring, and connectors for dirt and damage before and after each use.
- Inspect the fan filter. Replace the filter if it is torn, severely dirty, or otherwise damaged.
- At the end of each working day, clean the VERUS housing, wiring, and connectors with a clean damp cloth.

IMPORTANT:

Do not use any abrasive cleansers or automotive chemicals on the VERUS Diagnostic Tool.

13.4 Fan Filter Service

The fan filter should be periodically replaced to ensure an unrestricted source of cooling air to the Diagnostic Tool. Replacement intervals vary depending upon tool use and environment, replace as needed.

**To replace the fan filter:**

1. Clean off any dirt from the area around the filter.
2. Remove the old filter.
3. Install the new filter.

13.5 Battery Pack Service

Follow all safety guidelines when handling the battery pack.

WARNING



Risk of electric shock.

- **Prior to recycling batteries, protect exposed terminals with heavy insulating tape to prevent shorting.**
- **Disconnect all test leads and turn Diagnostic Tools off before removing end grips.**
- **Do not attempt to disassemble the battery or remove any component projecting from or protecting the battery terminals.**
- **Do not expose the Diagnostic Tool or battery pack to rain, snow, or wet conditions.**
- **Do not short circuit the battery pack terminals.**

Electric shock can cause injury.

WARNING



Risk of explosion.

- **The Lithium battery is factory replaceable only, incorrect replacement or tampering with the battery pack may cause an explosion.**

Explosion can cause death or serious injury.

13.5.1 Battery Pack Safety Guidelines

IMPORTANT:

The battery pack contains no user serviceable components. Tampering with the battery pack terminals or housing will void the product warranty.

Keep the following in mind when using and handling the VERUS battery pack:

- Do not short circuit battery pack terminals.
- Do not immerse the VERUS Diagnostic Tool or battery pack in water, or allow water to enter the Diagnostic Tool or battery pack.
- Do not crush, disassemble, or tamper with the battery pack.
- Do not heat the battery pack to over 100°C (212°F), or dispose of it in a fire.
- Do not expose the battery pack to excessive physical shock or vibration.
- Keep the battery pack out of reach of children.
- Do not use a battery pack that appears to have suffered abuse or damage.
- Charge the battery pack in the appropriate charger only.
- Do not use a battery charger that has been modified or damaged.
- Use the battery pack for the specified product only.
- Store the battery pack in a cool, dry, well ventilated area.



NOTE:

The battery pack should be used within a short period of time (about 30 days) after charging to prevent loss of capacity due to self-discharging.

If long-term storage of the battery pack is necessary, it should be stored in a cool, dry, well ventilated place with a 30 to 75 percent state of charge to prevent loss of characteristics.

To prolong the life of your battery, power off the Diagnostic Tool or place it into hibernation mode when not in use. The VERUS Diagnostic Tool has a built in charger that recharges the battery on demand whenever it is connected to a power source. A Smart Battery Charger, which prolongs battery life and improves performance, is available as an option.

The optional Smart Battery Charger ensures maximum performance by cycling the battery to a complete discharge state, then slowly drawing it up to a full charge. This over-night charging cycle is highly recommended for Diagnostic Tools that are subjected to heavy usage.

13.5.2 Replacing the Battery Pack

If the battery pack no longer holds a charge, contact your sales representative to order a new one.

IMPORTANT:

Replace the battery pack with original Snap-on replacement parts only.

**To replace the battery pack:**

1. Remove the right-side handgrip from the Diagnostic Tool.
2. Depress the lock tab on the back side of the battery pack.
3. Slide the battery pack clear of the Diagnostic Tool.
4. Fit the new battery pack into the slot.
5. Install the handgrip.

13.5.3 Disposing of the Battery Pack

Always dispose of a lithium-ion battery pack according to local regulations, which vary for different countries and regions. The battery pack, while non-hazardous waste, does contain recyclable materials. If shipping is required, ship the battery pack to a recycling facility in accordance with local, national, and international regulations. For additional information contact:

- North America—Rechargeable Battery Recycling Corporation (RBRC) at <http://www.rbrc.org> or <http://www.call2recycle.org>, or call 1(800) 822-8837 (USA)
- United Kingdom—Electrical Waste Recycling Company at <http://www.electricalwaste.com>
- Australia—Australian Battery Recycling Initiative <http://www.batteryrecycling.org.au>
- New Zealand—Ministry for the Environment <https://www.mfe.govt.nz/issues/waste/streams/batteries.html>

Products bearing the WEEE logo (Figure 13-2) are subject to European Union regulations.



Figure 13-2 *sample WEEE logo*

**NOTE:**

Always dispose of materials according to local regulations.

Contact your sales representative for details.

13.5.4 Battery Pack Calibration

The VERUS battery pack contains a micro controller that monitors the battery pack characteristics and maintains an internal “fuel gauge”. The internal fuel gauge may lose some accuracy after many cycles of partial discharge and charge. Should this happen, the fuel gauge can be calibrated with the following procedure:



To calibrate the battery pack fuel gauge:

1. Fully charge the battery pack.
2. Fully discharge the battery pack at a steady rate.

IMPORTANT:

The battery must be completely discharged! Operate the Diagnostic Tool until it shuts down by itself due to a lack of power. Continue operating the tool when the “low battery” warning displays, do not begin charging until after the tool has automatically shut down.

3. Fully charge the battery pack.



NOTE:

It is not recommended to perform the calibration procedure more than once within 30 days.

The optional Smart Battery Charger automatically cycles the battery pack to calibrate it.

13.6 VERUS System Restore

The VERUS Diagnostic Tool contains Snap-on System Restore software that returns the tool to original factory condition following a catastrophic failure. Use the procedure below to restore the system if your VERUS Diagnostic Tool does not start the Windows operating system, or if the hard disk drive or other system files have become corrupted.

IMPORTANT:

All data on the VERUS hard disk drive is erased during a system restore. If at all possible, make a back up copy of any personal or saved data before proceeding.

It is highly recommended that the VERUS Diagnostic Tool be connected to an AC power source when performing a system recovery. If AC power is not available, make sure the internal battery pack is fully charged.



To restore the VERUS system:

1. With the VERUS Diagnostic Tool turned off, connect an external keyboard to the USB jack on top of the VERUS Diagnostic Tool.
2. Select and hold the **Left ALT** key on the keyboard, then press the VERUS **Power** button.
A dialog box warning that all data on drive C will be deleted and replaced with original factory data displays.
3. Select **OK** to proceed with the restore, or **Cancel** to abort.

The system restore begins and the time remaining until completion displays if OK is selected. The operation typically takes from 10 to 20 minutes.

4. When the “finished successfully” message displays, select **OK** to reboot the system.
The Windows system reseal program automatically runs on start up and a dialog box displays. Once the reseal completes, the dialog box closes, Windows starts, and the VERUS Diagnostic Tool is ready for use.

If you receive an error message while starting the VERUS software, the license key may need to be updated or replaced. Contact your sales representative or Customer Care.

**NOTE:**

After using VERUS System Restore software, the Diagnostic Tool is restored to original factory condition, so any software updates will need to be reloaded onto the VERUS system. Contact your sales representative or Customer Care for additional information.

13.7 Wireless Scan Module

When using the wireless Scan Module, make sure to do the following:

- Check the housing, wiring, and connectors for dirt and damage before and after each use.
- At the end of each working day, clean the VERUS housing, wiring, and connectors with a clean damp cloth.

IMPORTANT:

Do not use any abrasive cleansers or automotive chemicals on the Scan Module.

13.7.1 Replacing the Protective Handgrip

The soft protective handgrip that covers the outer edges of the Scan Module is easily replaced should it become worn or damaged. Contact your sales representative for replacement parts.

**To replace the protective handgrip:**

1. Disconnect the data cable, and any other cables, if attached to the Scan Module.
2. From the bottom of the Scan Module, gently lift up and out on one side of the handgrip to free it from Scan Module housing.
3. Repeat step 2 to loosen the other side of the handgrip.
4. Lift the handgrip off of the Scan Module housing.

**NOTE:**

The handgrip tapers toward the front of the Scan Module housing. Make sure the replacement handgrip is correctly oriented before attempting to install it.

5. Fit the new handgrip over the top, data cable end, of the Scan Module housing.
6. With your fingers, work the new handgrip onto the Scan Module housing from top to bottom. Make sure the tabs on the handgrip fit into the grooves on the housing.

Troubleshooting Bluetooth Communication Issues

The Scan Module is a wireless communications device that uses Bluetooth technology to transmit vehicle data to the Diagnostic Tool without a physical connection. The working range of the transmitter is about 30 feet (9.14 m). Scan Module operations can be impacted when signal interference, or some other condition, disrupts or impairs the wireless communication network. These interruptions are usually temporary and easily repaired.



Indicators of wireless communication interference include:

- Slow Scan Module response accompanied by “Error 101” message.
- Slow Scan Module response accompanied by “Error 404” message.
- “Error Occurred” Message when trying to use the Scan Module.
- “Error Occurred” Message after 20 or more minutes sitting idle, particularly if the devices have been stationary.

Verifying the Hardware Status is always the first step in troubleshooting a Bluetooth issue.

Hardware Status

The Hardware Status indicators in the lower-right corner of the Home screen provide a quick reference to wireless operations. The background color of the status indicator icon represents the condition of the wireless connectivity to that device. Icon status is shown in the table below

Hardware Icon	Background Color	Condition	Action
	Red	Not Paired	Pair the Scan Module to the Diagnostic Tool. See “Paired Devices” on page 130 for instructions.
	Grey	Paired, but Not Communicating	You may have moved out of range. Move the Diagnostic Tool closer to the Scan Module to reestablish communications. If connectivity is not restored, perform the “Recovery Procedure” on page 141.
	Blue	Paired and Communicating	Hardware status is good and Bluetooth should be functional. Verify that the green Bluetooth LED on the front of the Scan Module is flashing. If there is no connectivity, perform the “Recovery Procedure” on page 141.

The three light emitting diodes (LEDs) on the faceplate of the Scan Module let you know at a glance whether or not there is an active connection between the two modules. The two green LEDs (Vehicle Power and Bluetooth) both flash on and off when the Scan Module and Diagnostic Tool are actively communicating through a wireless connection. The red Communication LED flashes on and off when the Scan Module is performing an internal self test, and is illuminated continuously if there a failure is detected ([Figure A-1](#)).

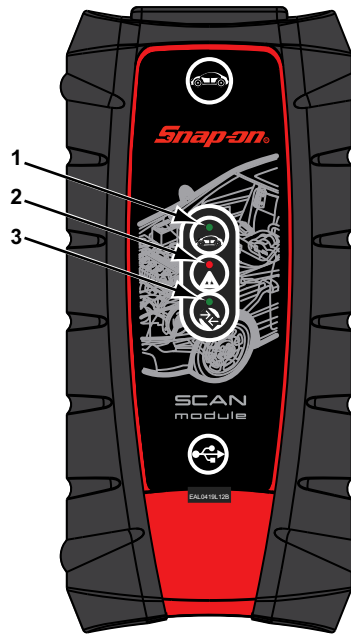

- 1— **Vehicle Power**—green LED, flashes during wireless communications
- 2— **Communication**—red LED, illuminates if there is a communications failure
- 3— **Bluetooth**—green LED, flashes during wireless communications

Figure A-1 Scan Module LEDs

Recovery Procedure

This is a quick and easy method that reestablishes connectivity between the Diagnostic Tool and the Scan Module. If Bluetooth connectivity remains unavailable following recovery, use one of the alternate procedures to restart the system.



NOTE:

This product is intended to be used by professional technicians in a garage environment. Electrostatic discharges may happen occasionally and cause a loss of communication. To restore communication disconnect and reconnect the communication cables and follow screen prompts.



To recover wireless connectivity:

1. Disconnect the Scan Module from the vehicle.
2. Navigate to the Home Screen on the Diagnostic Tool.
3. Select **Exit** to close the ShopStream Diagnostic Suite.
4. Connect the Scan Module to the vehicle.
5. Select the **ShopStream Diagnostic Suite** icon on the desktop and the.



Figure A-2 Sample ShopStream Diagnostic Suite desktop icon



NOTE:

The ShopStream Diagnostic Suite can also be started from the Windows Start menu.

Alternate Procedures

Use these methods as an option to the Recovery Procedure, or when recovery fails to restore the wireless connection.

USB Procedure

This method establishes a “hard-wired” USB cable connection between the modules.



To create a USB connection:

1. Carefully slip the ends of the handgrip off of the sides of the Scan Module housing.
2. Lift open the hinged cover on the base of the Scan Module.

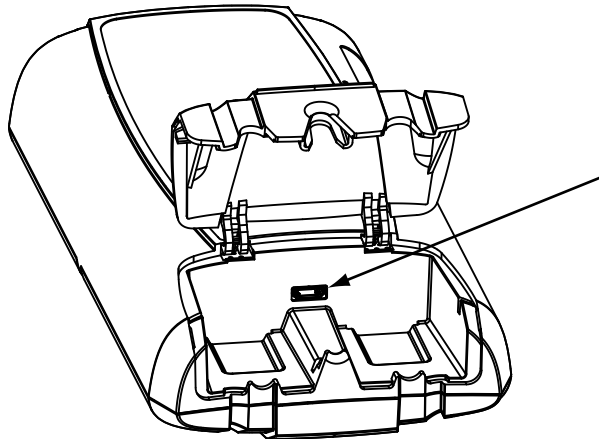

Figure A-3 Scan Module USB jack, handgrip removed

3. Plug the small end of the USB cable into the USB jack on the Scan Module.
4. Plug the large end of the USB cable into a USB jack on the Diagnostic Tool.
Scanner functionality should be restored immediately once the USB connection is complete. If not, suspect a hardware failure. The Diagnostic Tool and Scan Module are both fully functional, so you can complete your testing with the USB connection intact.

ShopStream Diagnostic Suite Restart Procedure

This method, which closes and restarts the ShopStream Diagnostic Suite software, takes about two minutes to complete.



To restart the ShopStream Diagnostic Suite:

1. Navigate to the Home Screen on the Diagnostic Tool.
2. Select **Exit** to close the ShopStream Diagnostic Suite.
3. Wait for the Scan Module Communication LED to stop flashing.
4. Select the ShopStream Diagnostic Suite icon on the desktop.
The ShopStream Diagnostic Suite should open with connectivity restored.

Windows Reboot Procedure

This method, which completely shuts down the Diagnostic Tool, takes several minutes to complete.



To reboot the Diagnostic Tool:

1. Disconnect the Scan Module from the vehicle.
2. Navigate to the Home Screen on the Diagnostic Tool.
3. Select **Exit** to close the ShopStream Diagnostic Suite.
4. Select **Start** in the lower-left corner of the screen to open the menu.

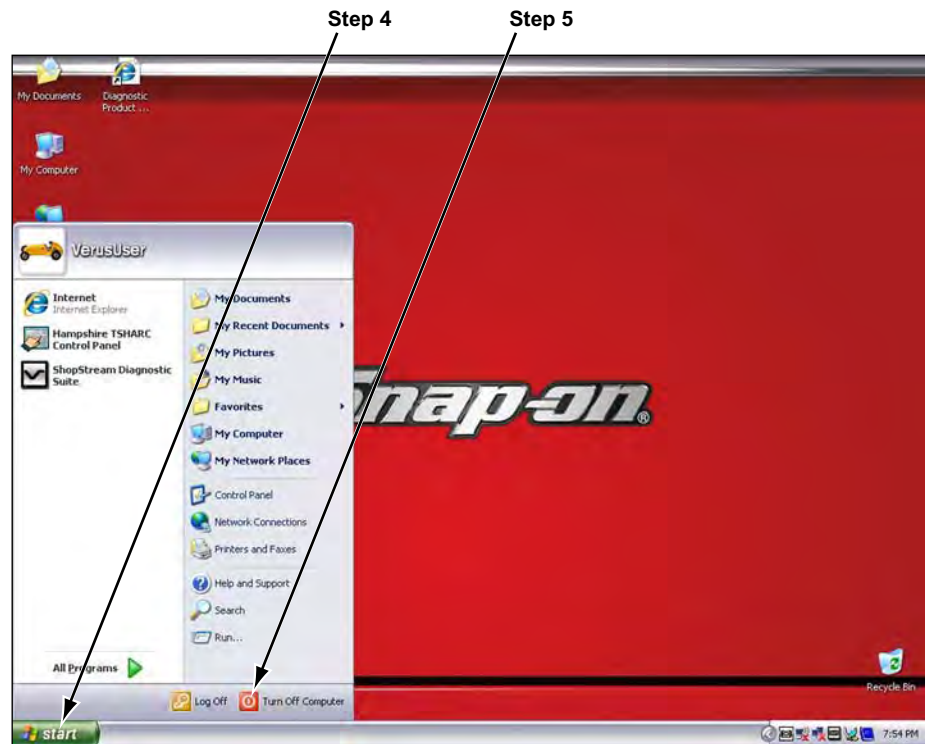

Figure A-4 Sample Windows Start menu

5. Select **Turn Off Computer** from the menu.
6. Select **Turn Off** when the Confirmation window opens.



Figure A-5 Sample shutdown confirmation window

7. Wait for the tool to completely power off, then press the **Power** button to restart the Diagnostic Tool.
8. Connect the Scan Module to the vehicle once the ShopStream Diagnostic Suite opens.

Index

Numerics

10-Minute Electronic Class 67
15-Minute Ignition Class 67
20-Minute current ramp classes 67

A

AC/DC power supply 10
actuator tests 33
alarms 48
alligator clips 79

B

battery pack 10
 calibrating 138
 disposing of 137
 handling 136
 replacing 137
 specifications 7
Bluetooth connectivity 140–143
bold text 1

C

cables 78–80
 channel 1 78
 channel 2 78
 channel 3 79
 channel 4 79
 inductive RPM pickup 80
 secondary coil adapter 80
 secondary ignition clip-on wire adapter 80
capabilities, hardware 76
charging station 10
cleaning the unit 135
clear codes 60
clearing codes 42
Codes
 checking 59–60
Codes Menu 33, 41–44
codes. *See* diagnostic trouble codes (DTCs)
communication protocol 65
Component Information 70
component information 70–71
connecting to a test vehicle 74
connecting to a vehicle 27, 34
Connector Information 64
custom data list 47

D

Data Display 34–50
Data Graph 36
Data Manager 120
 properties 126
data parameters
 displaying 33, 41
delete 118
demonstration programs 20
diagnostic connector
 location 64
diagnostic trouble codes (DTCs) 33
digital meter 79
dimensions, display device 7
dimensions, Scan Module 12
disaster recovery 138
Disconnecting from the vehicle 21
Display Device
 connecting wireless devices 130–131
display, specifications 7
DTC status 43

F

fan filter replacement 135
Features & Benefits 68
Freeze Frame/Failure Records 42
functional tests 33, 44

G

generic functions 46
Graph View 36
Guided component tests 44, 71–74

H

hardware overview 77
Help 128
How To... 67

I

identifying a test vehicle 34
Illustrated Terms and Definitions 67
inductive RPM pickup adapter 80
information tests 44

M

Main Body 30, 84

maintenance
 battery pack 136
 maintenance tips 134
 Making Selections 87
 Scanner 32
 manual conventions 1–2
 Measurement Out of Range 90
 menu button 15, 74
 Messages
 confirmation 32
 error 32
 important 2
 note 2
 warning 32
 meter capabilities 76

N

No-Start Basics 67

O

O2 Sensor and Feedback System Analysis 67
 OBD Diagnose 61–65
 OBD Health Check 59–64
 operating temperature 7, 12
 Operations
 Guided Component Tests 71
 operations
 connecting to a vehicle 27, 34
 identifying a test vehicle 34
 selecting a system to test 34
 selecting tests 34
 oxygen sensor tests 46

P

parameters. See data parameters
 pending codes 60
 performing tests 74
 PIDs. See data parameters
 Power
 conservation 9
 power sources 10, 12
 AC/DC power supply 10
 Power User Tests. See tests
 probe
 test 79
 procedures 2

R

readiness monitors 60
 recording data 86
 Repair Information 103–114
 reset tests 44

S

Safety iv
 Scale 53
 Scan Module
 disconnecting 21
 handgrip replacement 139
 introduction 11
 operations 19, 57
 scale 53
 specifications 12
 sweep 54
 trigger 38
 wireless communication 11
 wireless connection 131–132
 Scanner
 connecting 27
 custom data list 46–47
 data list 34
 demonstration program 20
 main body 30
 screen layout 29
 toolbar 46–48
 Scanner Toolbar 30, 46–48
 Scope
 record/playback controls 86
 Scope Layout 82
 Scope Multimeter
 playback toolbar 86
 scope multimeter toolbar 84
 screen messages 32
 search 118
 secondary coil adapter 80
 selecting a system to test 34
 selecting tests 34
 Smart Battery Charger 137
 stand, the 8
 standby mode 9
 storage temperature 8, 12
 subsystem tests 44
 Sweep 54
 symbols 1
 System Settings 130–132
 system tests 33, 44

T

temperature
 operating 7, 12
 storage 8, 12
 terminology 1
 test leads 78–80
 test probes 79

- tests
 - actuator 33
 - component 44
 - functional 33, 44
 - Power User 67
 - selecting 34
 - subsystem 44
 - system 33, 44
 - tips 67
- toggle tests 44
- Toolbar
 - Vehicle History 116
- toolbar
 - record/playback controls 86
 - Scanner 30, 46
- touch screen
 - calibrating 134
- Trigger
 - setting 38
- trigger
 - condition 38
- trouble codes. See diagnostic trouble codes (DTCs)

U

- Units Setup 98

V

- variable control tests 44
- vehicle diagnostic connectors 27
- Vehicle History 115–119
 - activate 117
 - delete 118
 - operations 117
 - screen layout 115
 - search 118
 - settings 119
 - toolbar 116
 - view 117
- vehicle identification 115–116
- VERUS toolbar 15–18
- View 117
- Viewing component information 70

W

- weight, display device 7
- weight, Scan Module 12
- wireless
 - pairing devices 130–132
- wireless communication 11, 140
- Wireless recovery 141